

Workplace chairs

General catalogue



Production



ESD area



Laboratory

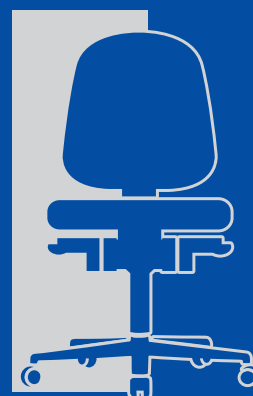

Cleanroom



Standing work



Mmax.nl

Achter de Kerken 49 1391LC ABCOUDE

T. 0031(0) 294285215

F. 0031(0) 294285204

E. info@Mmax.nl | W. www.Mmax.nl

bimos

bimos

Welcome to the world of workplace chairs.

This general catalogue of workplace chairs will give you the perfect tool to help you plan your workplace. Work in production facilities, ESD areas, laboratories or in places where you have to work standing up – all these scenarios entail a whole range of requirements relating to specific activities, and also to design and ergonomics.

This catalogue is not designed just to give you an overview of our innovative products in these areas. We see it as a compendium of seating outside the office. So dive into this world of operational seating, and find out for yourself the most important issues in each area of work.

So let's get going: let's discover how dynamic seating can be.



Contents

Useful facts

Useful facts about bimos and what makes a good workplace chair

We are bimos 6 – 7

We have the perfect solution 8 – 9

Five sustainability guidelines 10 – 11

A good workplace chair 12 – 15

Functions and ergonomics 16 – 17

Everything you need to know about chairs 140

Options guide 141

Guide to finishes 142 – 143

Dimensions 144 – 146

Production

Perfect seating solutions for production facilities 18 – 21



Neon 22 – 29
New generation workplace chairs



Sintec 30 – 35
The tried and tested solution for custom seating



All-In-One 36 – 41
The all-inclusive seating solution



Solitec 42 – 45
The robust solution for maximum flexibility



Isitec 46 – 49
The practical solution for everyday use



Unitec 50 – 53
The low-cost solution for solid performance



Stools 54 – 55
Industrious assistants



Sintec 160 58 – 59
The workplace chair for people up to 160 kg



24h Chair 60 – 61
The high-flier that never takes a break

ESD area

Reliable electrostatic discharge protection for electronic workstations 62 – 65



ESD Neon 66 – 71
New generation workplace chairs



ESD Sintec 72 – 77
The tried and tested solution for custom seating



ESD Basic 78 – 81
The tried and tested all-rounder for use in ESD areas



ESD Unitec 82 – 85
The low-cost solution for solid performance



Stools / footrests for ESD areas 86 – 87
Industrious assistants

To make it easier to use and in the interests of clarity our catalogue uses a colour-coding system for the various application areas covered.

Laboratory

Sophisticated seating solutions for your laboratory 88 – 91



Labster 92 – 95
The world's first real laboratory chair



Neon Laboratory 96 – 101
Comfort in your laboratory



Basic Laboratory 102 – 105
The tried and tested all-rounder for use in laboratories



Sintec Laboratory 106 – 107
The tried and tested solution for custom seating



Isitec Laboratory 108 – 109
The practical solution for everyday use

Cleanroom

Indispensable – top-class certified solutions for the cleanroom 110 – 113



Cleanroom Plus 114 – 117
The comfortable option for great performance in the cleanroom



Cleanroom Basic 118 – 121
The tried and tested all-rounder for use in cleanrooms



Cleanroom stools 122 – 123
Industrious assistants

Standing work

Relief from stress and strain for people who cannot sit down to work 124 – 127



Fin / ESD Fin 128 – 131
The revolution in standing work



Labster standing rest for laboratory, cleanroom and ESD 132 – 133
Standing rest for laboratory – and more



Industrial standing rest / ESD standing rest 134 – 135
Support for your everyday work



Flex 136 – 137
The best support for sitting, standing and combined workplaces



Sweemo 138 – 139
Dynamic seating

We are bimos

and we are the leading manufacturer of workplace seating in Europe. For decades, we have focused on providing specialised seating solutions for work away from the conventional desk. As an Interstuhl brand (the office chair specialist), we are backed up by 40 years of development and production experience. And we are able to combine the latest research and technology with traditional craftsmanship. Consequently, in addition to understanding our product, we also know exactly what you need.

We see the chair as a tool that represents an important link between people and the production equipment they use. Right from the very start, our business has been driven by innovation. We can offer the right stool for any working area. Our range extends from sturdy all-rounders for production workstations through to highly sophisticated laboratory chairs.

Despite the huge diversity of products on offer, all our seating solutions have a common objective: To provide people with optimum support. Our chairs certainly do that, but they also leave you free to move. They are flexible, yet resilient. They fit perfectly into the working environment without requiring users to adapt. That is the ideal for which we stand.

We are bimos.



We have the perfect solution

for every requirement ...

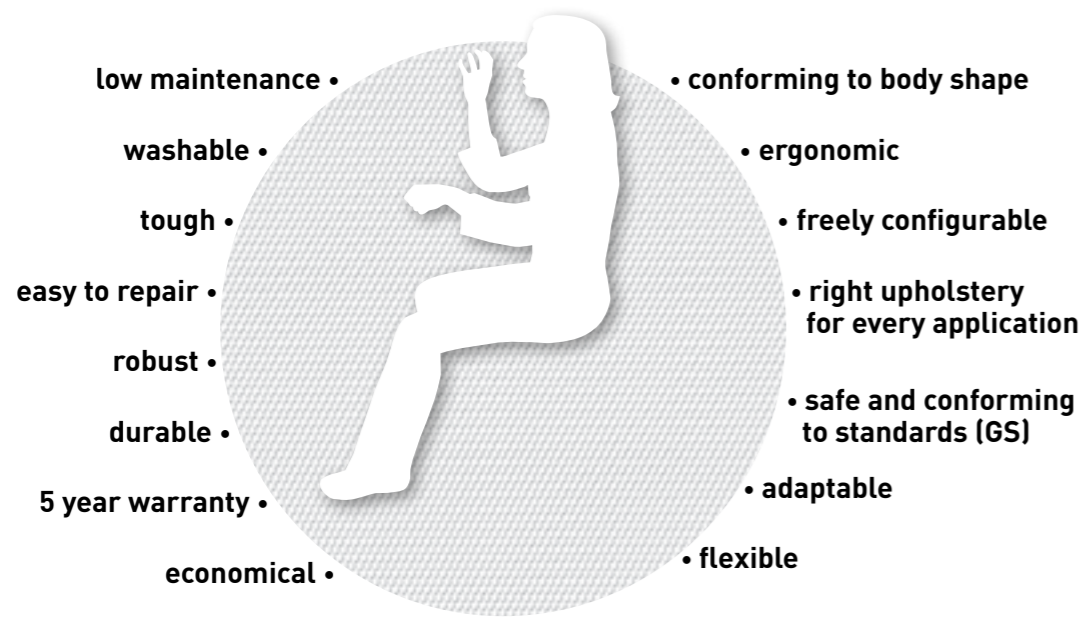

New technical developments constantly make fresh demands of workplace chairs, which is why we invest so much energy in research. This means maintaining close contact with practitioners, and co-operating with various experts, for instance from the Fraunhofer Institute.

Even the best chair can only really be effective when it is completely self-explanatory, and when the user wants to use it. This is why we work with the best product designers in Germany.

Innovation must never be to the detriment of safety, quality or sustainability. Compliance with standard DIN 68 877, the GS

tested safety mark, certification in accordance with DIN EN ISO 9001, environmental management in accordance with DIN EN ISO 14001 and EMAS regulation, and last but not least, our five year warranty are all clear proof of just how committed we are in this respect.

In addition to the innovation, quality and sustainability of our products, we are also extremely proud of our modular seating concepts. The perfect specialist solution for every working environment is right here.

Just let us know what you need.
We have the solution.

...and every conceivable workplace



Five guidelines ...

... for sustainability



Average usage of materials in a workplace chair

We are committed to responsible use of resources and to the world in which we live. We were one of the first companies in our sector to receive certification according to EMAS, in 1995. Our commitment to sustainability was acknowledged in 2010 with the Environmental Award for Businesses from the State of Baden-Württemberg. Neon is the first workplace chair to have been awarded the Blue Angel eco-label.

The following five guidelines underlie every single new bimos development:

Recycling starts at the development stage

Our seating solutions are designed in such a way that almost complete material recovery is possible. To ensure this, we avoid – wherever possible – using composite materials. Recycled materials are always preferred in the manufacture of our chairs.

Quality is the best protection for resources

Nothing is better for the environment than a product which does not have to be replaced. When we develop a product, one of our principal aims is to ensure it has a really long life.

Modular design as service-plus

Our chairs are designed so that all components can be simply and quickly replaced at any time, and we ensure that our replacement parts are available for at least 10 years.

Green values in black and white

Every one of our chairs comes with an environmental data sheet. This shows the key environmental parameters of all components: from the humble screw to the upholstery.

Our chairs have a green home

Even in areas not directly related to what we produce, we are continually optimising our processes, and working to ensure that we remain at the forefront of environmental awareness.

A good workplace chair ...

... can increase efficiency at your company

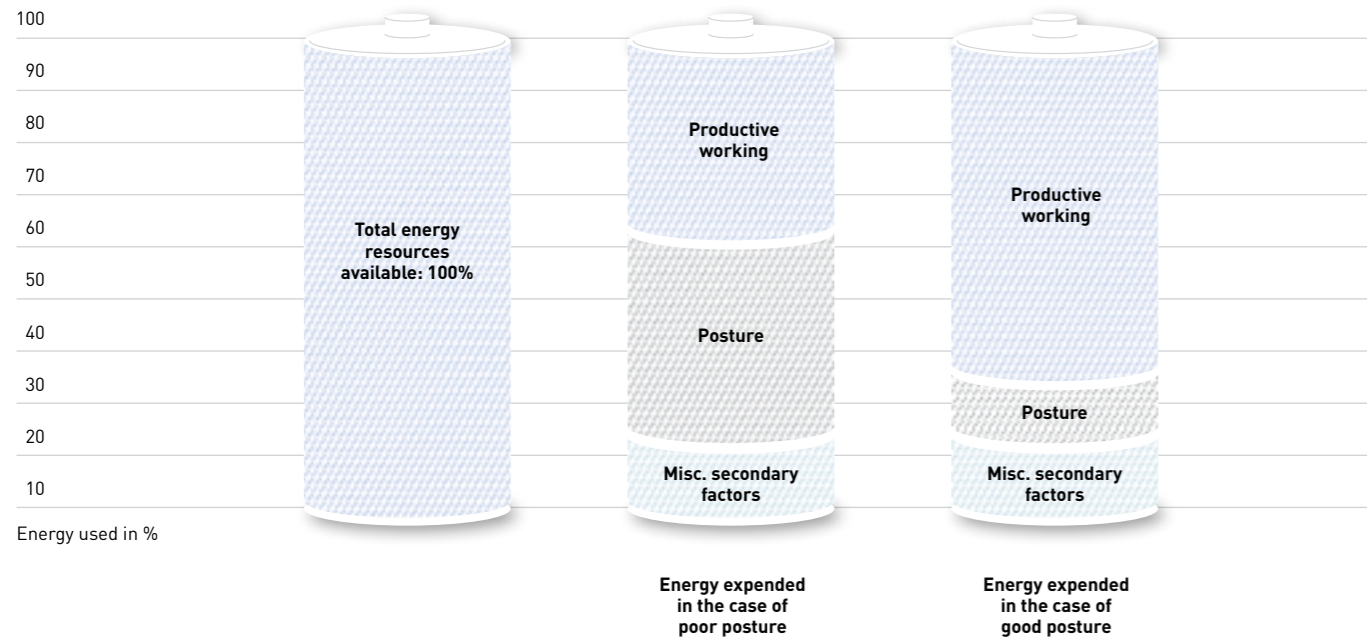

Economy means making the best use of energy

Research shows that up to 40% of people's productivity at work can be lost through poor posture. When the body is under strain, it has to compensate for any deficiencies in the workplace. That requires strength and energy that can be put to better use in working, rather than wasting them on sitting. So the influence of a workplace chair on the productivity of a company is enormous.

A good workplace chair supports the sitter, and prevents a person from getting tired quickly. This improves both performance and concentration. Errors can be reduced by up to 20%.

Economy means when long-term investment pays off

The quality of a good workplace chair is evident in its materials and craftsmanship as much as in its basic concept. Bimos seating solutions are very well aware of this. Long-term durability, replaceable individual parts, and the possibility of purchasing individual components at any time combine to give you maximum flexibility.

bimos exclusively uses materials that have been subjected to rigorous testing. We were the first German manufacturer of workplace chairs to fulfil all the requirements of the standard DIN ISO 9001. We are so confident of the quality of our products that we give all our chairs a warranty of five years.

- boost the performance of your staff
- raise the quality of work
- invest in the future

... ensures safety in the workplace

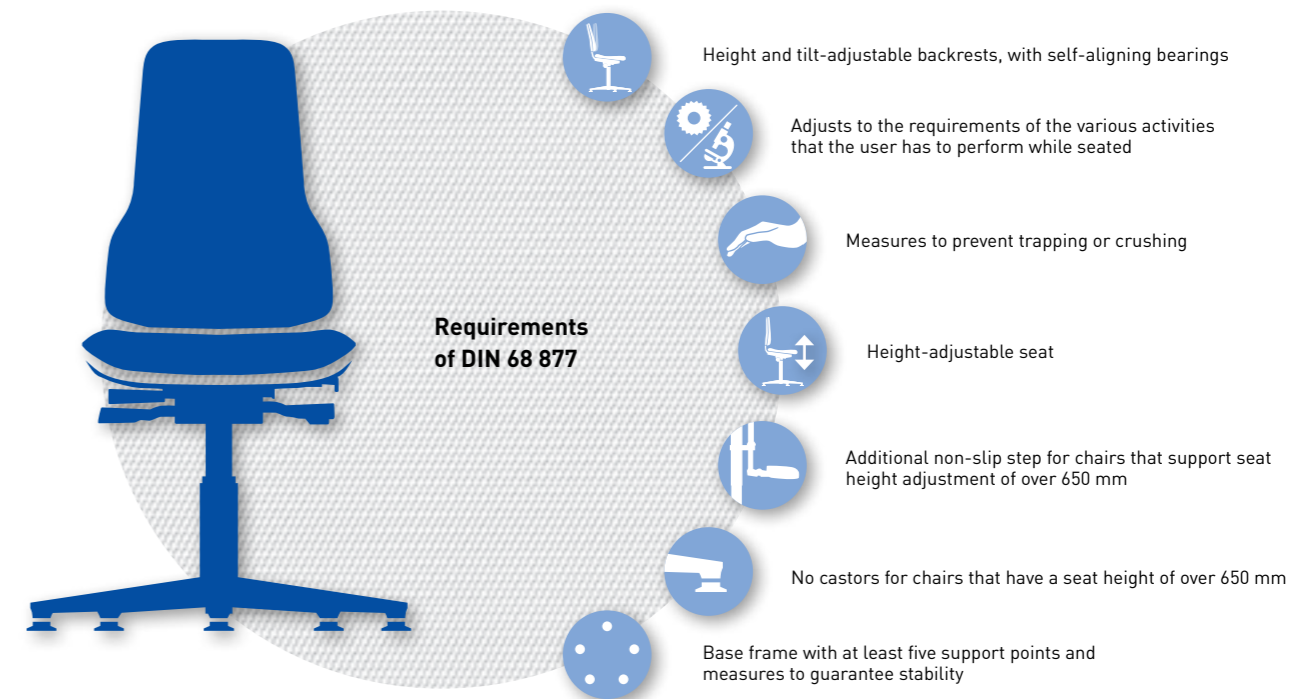

We abide by all safety guidelines ...

A good workplace chair must become an integral part of your company's health and safety arrangements. This applies to the way in which the chair is constructed, but it is just as important that the chair is perfectly suited for the tasks it is required to fulfil in your company. Yet the truth is that you often find chairs in an industrial setting that are not suitable for use there, e.g. office chairs.

Naturally, all bimos chairs fulfil standard DIN 68 877 and all carry the GS safety mark for tested safety. But the safety requirements we demand of our chairs go far beyond those given in the standard.

- safety depends on purpose
- don't cut corners on safety
- prevent accidents before they happen

... and we are still not satisfied.

At bimos, we anticipate every possible danger of injury, and prevent it from happening. We are in constant contact with experts in the field, and co-operate with well-respected research organisations such as the Fraunhofer Institute.

In addition to our solid construction and safe mechanisms, it is vital in industry that a chair should take account of the human safety factor. If humans cannot work in a relaxed and concentrated manner, then that is when dangerous mistakes can be made. The only chair that promotes safety in your company is a chair that takes the strain.

A good workplace chair ...

... protects the health of your employees

The amount of money lost through a single day's illness

Approx. € 500,-

A single lost working day will actually cost you more than purchasing an ergonomic chair!

Approx. € 250,-

The amount of money required to purchase an ergonomic workplace chair

... is a competitive advantage

bimos



A range designed to bring you pure pleasure: Seating solutions from bimos

Protect your most valuable asset

The most valuable asset of any company is its staff. It is becoming more and more apparent that people's health can be affected by their work. Back pain is a frequent problem. Work outside the office environment makes special demands of a workplace chair. This is the point at which we should mention forward-leaning sitting posture. Our chairs support this posture, reducing the likelihood of muscle tension and circulation problems. Back pain in the lumbar region, pain in the neck and shoulders, headache, and swollen legs can also be effectively prevented. Bimos also has perfect solutions for activities that have to be carried out while standing up.

Invest in the health of your staff and save cash

Good workplace chairs relieve stress, help to correct postural problems, and so prevent injury from poor posture.

Once a person has back pain, it is likely to necessitate a relatively long time off work. With a good workplace chair you will find that costs arising from absence on sick leave will reduce significantly: one single day off sick costs more than an ergonomic chair. In addition to avoiding sick leave, a good workplace chair ensures that staff feel good at work, and promotes concentration and performance.

Satisfaction comes from being valued

An employee spends longer on average sitting on a chair every day than lying in bed. So a good workplace chair is a measure of the value you place on the people in your company. Particularly today when development and production workplaces are merging closer together, and such a "war for talent" is raging, good workplaces are becoming an indispensable tool for motivating your staff. In addition to health and practical aspects, comfort plays a huge role too. The touch and feel of a workplace, too, have a great influence on its perceived value.

Nothing shapes a workplace so much as the chair

The chair is the workplace. You feel good sitting on a good chair. Nothing pinches, nothing nips. It is comfortable, it supports you, and it doesn't force you to sit in a fixed position. A good chair adapts perfectly to a person and to a workplace. It supports the body even when a person is doing heavy physical work.

A good chair makes a massive contribution to people's happiness at work. At bimos, we want to give people this happiness: that's why we develop our chairs from one viewpoint only – that of the human being.

- protect your human resource
- successful health promotion begins with sitting
- stress-free working is the only healthy working

- comfort is not a luxury
- people only work well if they are sitting comfortably
- improve your work environment with good chairs

Functions and ergonomics

Adjust the chair, not the person

Production work makes huge demands on the workplace: people may be using a great deal of energy, they may be precision-working, or making repetitive movements. A workplace chair should not force the user to sit in a constrained position. It must suit its environment perfectly, must be adapted to the work involved, and above all must be adjustable to every person sitting on it. The human body is the measure. A workplace chair must be an equally good fit for anyone and everyone - men and women, small people and large, heavy and light, and young and old - which is why it is essential to have a sufficiently wide range of settings and adjustments.

Important functions for adjustment to individual body size

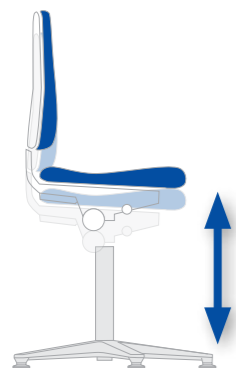

Seat height adjustment

Seat height adjustment allows adjustment to body size and height of workplace. The ideal seat height is when the knees, hips and elbows form an angle of at least 90°, with the feet resting flat on the floor.

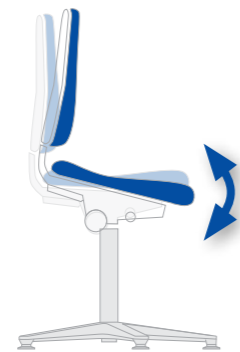

Seat tilt adjustment

Many jobs are carried out in slightly raised positions, and require people to bend forward. A correspondingly tilted seat provides a seat angle of at least 90°, while at the same time providing contact with the backrest.



Seat depth adjustment

The seat depth adjustment matches the depth of the seat to the size of the body, giving the best possible contact surface for the thighs. Contact with the backrest, and therefore the support it provides, are maintained.

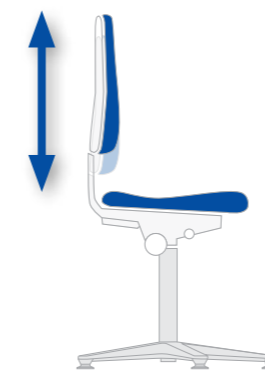

Backrest height adjustment

The backrest height adjustment ensures that a person is ideally supported - especially in the lumbar region - no matter how tall he/she is.



Weight regulation

By individually adjusting the pressure of the backrest, both light and heavy people can sit with the correct posture.

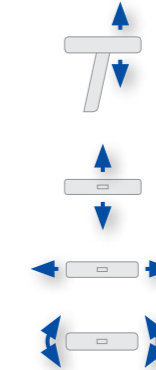

Armrests

Armrests have the important function of reducing the strain on the upper body and arms. The height, breadth and depth of our 4D armrests can be adjusted, and can also be swivelled

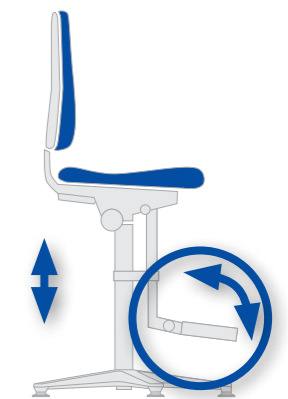

Foot support and mounting aid

The mounting aid is height-adjustable, and can be folded upwards by 90°.

Choice of two mechanisms for active-dynamic sitting



The permanent contact backrest ...

... follows the movements of the upper body, and ensures that the back always remains fully supported. The permanent contact backrest is ideal for people who have to lean forward for long periods of time, with only a small distance between eyes and workpiece (e.g. working in precision engineering or in the laboratory).



Synchronous technology ...

... provides an active-dynamic sitting experience with weight regulation. The seat and backrest accompany the body as it moves. This gives the user a feeling that can best be described as "weightless floating". The synchronous technology comes into its own where users are working at office-type working situations, working at a screen, or constantly changing their sitting position.

Production

“The chair is the most important piece of equipment in the world of production.”

KANTOOR

SCHOOL

Mmax

LABORATORIUM

MEDICAL

Production

Perfect seating solutions for production facilities

A workplace chair can only really be described as “good” if it fits in perfectly with the working environment. Each type of activity imposes its own particular requirements. That is why a good office chair will be designed to suit the working conditions found in offices. A chair that is to be used within a production context, on the other hand, will need to meet a completely different set of demands. bimos workplace chairs are setting new standards in this respect. They manage to combine maximum freedom of movement and adaptability with super sturdiness. From the ergonomic design of the seat and backrest and easily replaceable upholstery right through to the highly durable materials used, our seating solutions are the epitome of good design. As a result, not only do they satisfy the necessary standards, but are always developed in close collaboration with industrial doctors and other specialists in the field.



The activity determines the chair

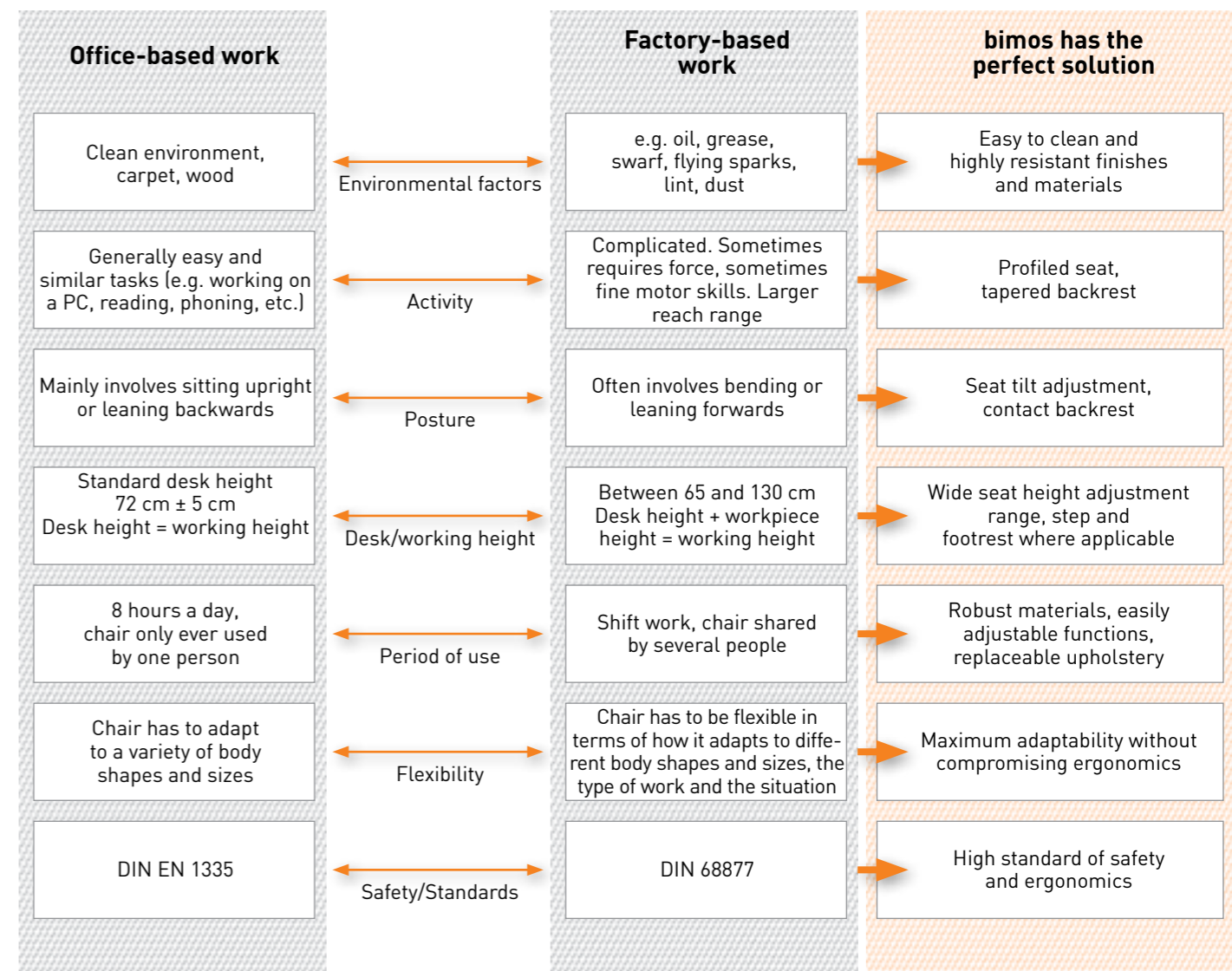

Neon



New generation workplace chairs

Neon is the flagship for modern industry. No other chair for use in manufacturing can boast such ergonomic features, such design or such comfort. Neon is based on findings from the Fraunhofer Institute's Arbeitswelt 2015^{plus} research. So Neon is the new generation workplace chair for the new generation of work. Simple production jobs are increasingly being replaced by

more complicated tasks. Similarly, office and manufacturing workplaces are merging closer and closer together, and demands on the workplace are increasing. Neon combines ergonomic and functional characteristics that have until now been unknown in production environments with optimum industrial characteristics. Its innovative 1+1 system of chair and upholstery combination provides flexibility and sustainability, and ensures that it is perfectly adapted to the particular area of work. Both operating Neon and sitting on it are highly comfortable experiences. Neon was designed by Phoenix Design, arguably the best design studio in Germany.

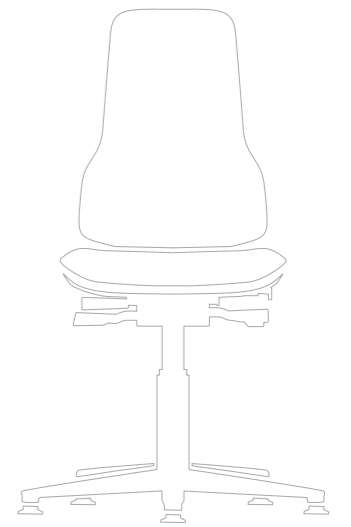

The Neon 1+1 system

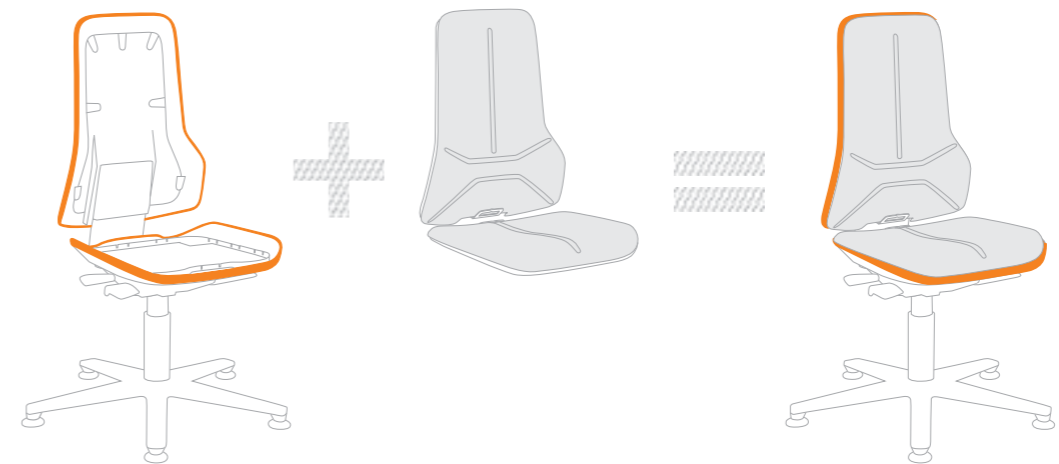

Neon consists of two elements: the chair element with base and mechanism and the upholstery element. This offers many advantages:

- **Sustainability:** when you need new upholstery, you do not need to dispose of the whole chair. You just change the upholstery with a single click.
- **Flexibility:** if Neon is to be used in another work area, it is only the upholstery element that needs to be changed.
- **Economy:** make a one-off investment in a chair, and then only replace upholstery when necessary. The decision to go for a Neon is a long-term investment.
- **Individuality:** upholstery determines use: changing upholstery surfaces to suit changing uses.
- **Speed of delivery:** The modular construction means that not every chair has to be individually finished after an order is received. This leads to extremely short delivery times.
- **Changeable upholstery:** different employees in the same workplace – for instance on multiple shift work – can use different upholstery.

Neon



Neon

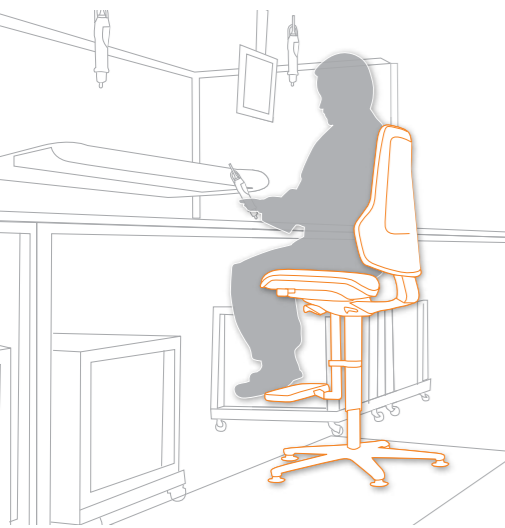

Design and materials

The most striking feature of Neon is its flex strip. It is made of soft plastic and serves to protect the chair and its environment. There is a choice of three colours for the flex strip. The chair itself consists of solid steel with an aluminium base. All the metal parts are black. The tough plastic parts are basalt grey. Neon is available with a choice of castors with load-sensitive brakes for hard floors or with abrasion-resistant glides. In addition, for the high version, there are optional Stop&Go castors available; also a height-adjustable mounting aid that can be folded upwards.

Mechanism (for precise details, see pages 16-17)

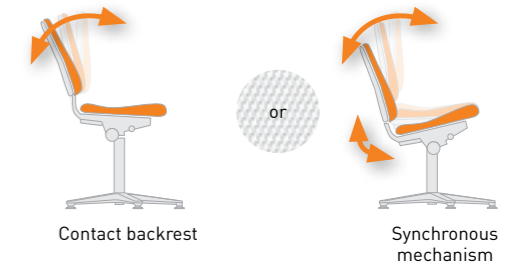

Ergonomic package (for precise details, see pages 16-17)

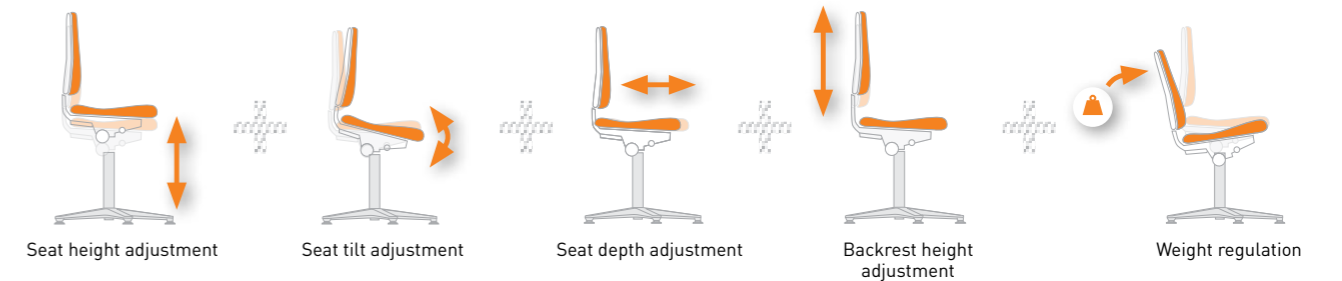

Accessories (for precise details, see page 141)

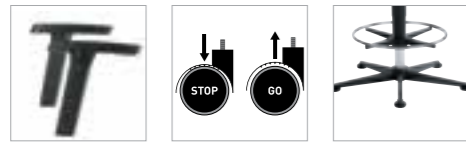

Multifunction armrest Stop&Go castors Foot ring



Neon 1 with glides

Seat height adjustment range: 450 to 620 mm.

| Design | Order no. |
|---|------------------------|
| Permanent contact inc. ergonomic package | 9560-Flex strip colour |
| Synchronous technology inc. ergonomic package | 9570-Flex strip colour |



Neon 2 with castors

Seat height adjustment range: 450 to 620 mm.

| Design | Order no. |
|---|------------------------|
| Permanent contact inc. ergonomic package | 9563-Flex strip colour |
| Synchronous technology inc. ergonomic package | 9573-Flex strip colour |



Neon 3 with mounting aid and glides

Seat height adjustment range: 590 to 870 mm.

| Design | Order no. |
|---|------------------------|
| Permanent contact inc. ergonomic package | 9561-Flex strip colour |
| Synchronous technology inc. ergonomic package | 9571-Flex strip colour |

Flex strip colour

| | Happy orange | Mars green | Cool grey |
|------------|--------------|------------|-----------|
| Flex strip | | | |
| Order no. | 3279 | 3280 | 3278 |













Neon

Design and materials

Neon's innovative 1+1 system allows you to change the upholstery with a single click, so that it adapts to any particular work environment. With the 1+1 system, you order chair and upholstery elements separately (please note that you can only sit on the chair with an upholstery element). There is an extensive range of upholstery

material available for the most varied uses: there is tough integral foam upholstery, which is able to withstand mechanical damage; easy-care synthetic leather that is soft and washable; robust and breathable fabric upholstery; as well as the world first – "Superfabric" – an innovative fabric covering that combines the advantages of fabric and integral foam.

Upholstery finish and colour options

| Finish | Black | Blue | Grey |
|-------------------------|---|---|---|
| Taff fabric |  |  |  |
| Order no. | TA01 | TA02 | TA11 |
| Magic synthetic leather |  |  |  |
| Order no. | MG01 | MG02 | MG11 |
| Integral foam |  |  |  |
| Order no. | 2000 | 2001 | 2002 |
| Superfabric |  |  |  |
| Order no. | SP01 | SP02 | SP11 |

"Superfabric" – a world first among cover materials

Neon is not just a trail-blazer in terms of ergonomics, design and comfort. It also sets standards in its choice of materials. Neon is the first workplace chair to make use of the "Superfabric" cover material. This consists of a textile substrate covered with micro-studs. This makes Superfabric upholstery breathable, soft and comfortable, and at the same time very tough, cut resistant, non slip and easy to clean.

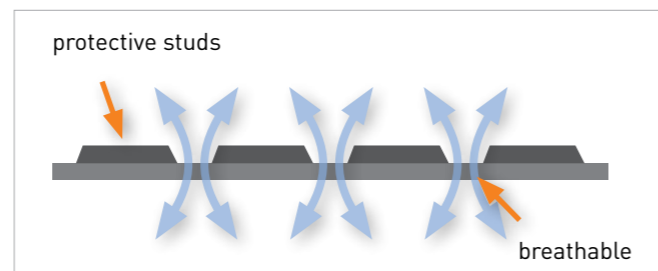

Partly hard, yet overall very soft.



Neon fabric upholstery

breathable, comfortable, soft, hard-wearing

| Design | Order no. |
|-------------|-----------------|
| Taff fabric | 9588-colour no. |



Neon synthetic leather upholstery

washable, low-maintenance, resistant to oil and disinfectants, soft and comfortable

| Design | Order no. |
|-------------------------|-----------------|
| Magic synthetic leather | 9588-colour no. |



Neon integral foam upholstery

extremely tough, durable, washable, capable of withstanding mechanical damage, resistant to flying sparks, resistant to mild acids and alkalines

| Design | Order no. |
|---------------|-----------------|
| Integral foam | 9588-colour no. |



Neon Superfabric upholstery

comfortable, soft, breathable, very tough, cut resistant, non slip, easy to clean

| Design | Order no. |
|-------------|-----------------|
| Superfabric | 9588-colour no. |

Sintec



The tried and tested solution for custom seating

Many of our industrial customers swear by Sintec, because it provides users with maximum flexibility and is completely user-friendly. Its superb ergonomic design and individual functions coupled with the wide selection of mechanisms make it the ideal chair for any workplace scenario.

Sintec's replaceable upholstery elements provide maximum flexibility. It is the combination of all these factors that makes Sintec our bestseller. It was precisely with this high standard of economics and functionality in mind that Sintec was developed in conjunction with the Fraunhofer Institute (IAO). The experts were so impressed by the results that they decided to award Sintec the Baden-Württemberg prize for innovation.

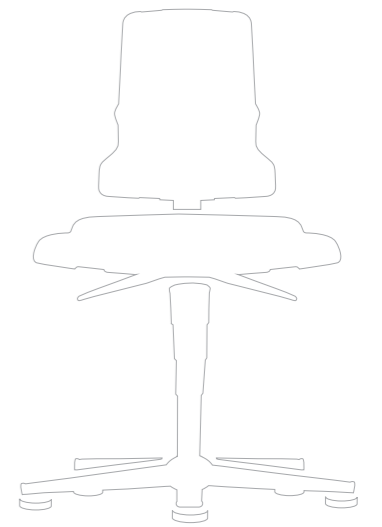

Easily replaceable seat and backrest upholstery

Various seat and backrest upholstery options are available for Sintec, enabling chairs to be perfectly adapted for any working environment. Changing the upholstery couldn't be easier thanks to the quick and convenient hook-on concept. But this does not mean that comfort is left to fall by the wayside: The upholstery provides a real feeling of luxury.

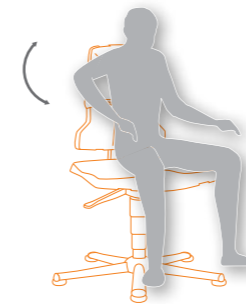

Anatomically designed backrest

The high backrest takes the strain off your spine and muscles. This is achieved by means of its special shape: wide at the bottom and narrow at the top. In this way the backrest provides optimum support for your lumbar region whilst allowing your arms and upper body the space and freedom they need higher up in order to move around.

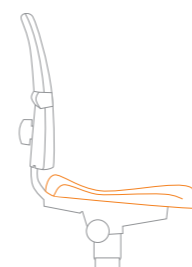

The ergonomic design of the seat increases performance

The anatomically designed seat automatically encourages you to sit correctly. It supports your bottom even when tilted, encourages precise motor function and ensures constant contact with the backrest. The distinctive pelvis support helps keep your pelvis upright and preserves the natural S-shape of your spine. These measures prevent tiredness and improve concentration and performance.

Sintec

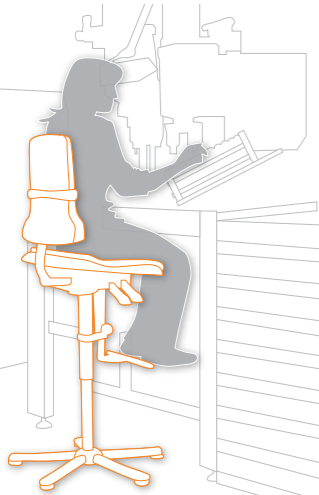

Design and materials

Sintec is equipped with robust plastic seat and backrest shells as standard. Various finish and colour options are available for the high-comfort replaceable upholstery for the seat and backrest (for more information, see pages 34/35). Sintec features a five-legged base frame with flat lines made from sectional steel tubing. The plastic and steel components are painted basalt grey (RAL 7012). Sintec can be supplied with special castors featuring load-sensitive brakes for hard floors or with abrasion-resistant glides as an option.

Mechanisms and functions (for precise details, see pages 16-17)

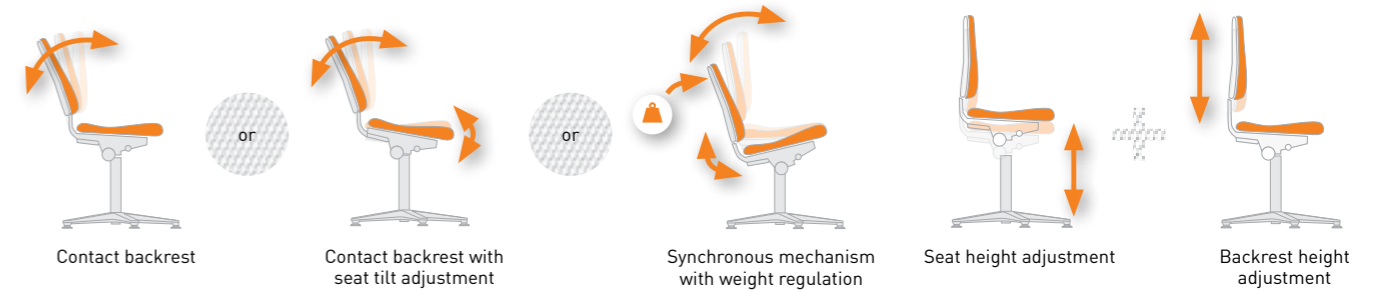

Options

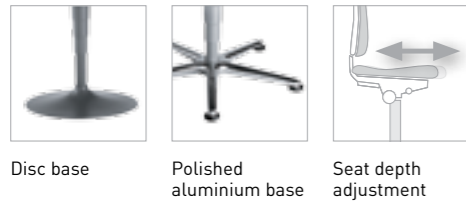

Accessories (for precise details, see page 141)

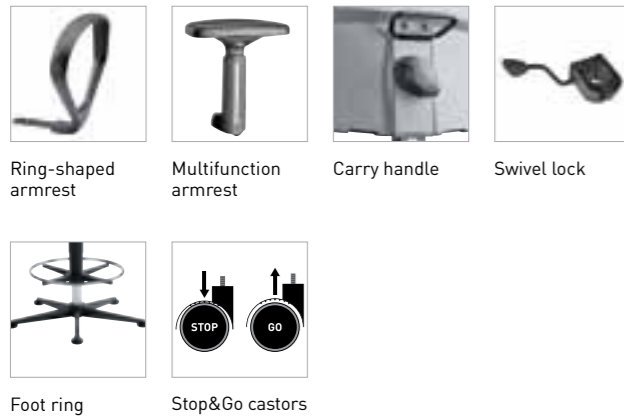

Sintec 1 with glides

Seat height adjustment range: 430 to 580 mm.

| Design | Order no. |
|--|-----------|
| Contact backrest | 9800-1000 |
| Contact backrest with tilting seat | 9810-1000 |
| Synchronous mechanism with weight regulation | 9820-1000 |



Sintec 2 with castors

Seat height adjustment range: 430 to 580 mm.

| Design | Order no. |
|--|-----------|
| Contact backrest | 9803-1000 |
| Contact backrest with tilting seat | 9813-1000 |
| Synchronous mechanism with weight regulation | 9823-1000 |



Sintec 3 with glides and step

Seat height adjustment range: 580 to 850 mm.

| Design | Order no. |
|--|-----------|
| Contact backrest | 9801-1000 |
| Contact backrest with tilting seat | 9811-1000 |
| Synchronous mechanism with weight regulation | 9821-1000 |

Sintec

Design and materials

Depending on where they are going to be used, all Sintec workplace chairs can be fitted with fabric, synthetic leather or hard-wearing integral foam upholstery. The upholstery is attached using a simple hook-on system. This innovative, yet straightforward principle means that you can adapt the chair to the individual workplace scenario. All Sintec replaceable upholstery provides a luxurious level of comfort.

Sintec replaceable upholstery

- Quick and easy to attach thanks to the hook-on system
- Can be changed at any time
- Highly economical, as upholstery can simply be swapped
- Improves the workplace's unique appeal and its flexibility
- Increases seat height by 20 mm

Functions



Upholstery with lumbar pad:
Provides exceptional support
for your lumbar region.

Upholstery finish and colour options

| Finish | Black | Blue | Grey | Red |
|--------------------------------|-------|------|------|------|
| Duotec fabric | | | | |
| Order no. | 6801 | 6802 | 6811 | 6803 |
| Genius fabric | | | | |
| Order no. | GE01 | GE02 | GE11 | |
| Stamskin Top synthetic leather | | | | |
| Order no. | 4524 | 4523 | 4521 | 4508 |
| Integral foam | | | | |
| Order no. | 2001 | | | |



Sintec integral foam upholstery

Easy-care, washable and robust covering, resistant to mild acids and alkalis and capable of withstanding mechanical influences. Structured surface for optimum climatic comfort.

| Design | Order no. |
|--------------------------------|-----------|
| Integral foam upholstery, blue | 9865-2001 |



Sintec fabric upholstery

Soft, breathable upholstery with hard-wearing cover fabric.

Sintec synthetic leather upholstery

Washable upholstery with Stamskin Top covering. Antibacterial, antimicrobial and antifungal.

| Design | Order no. |
|--------------------------------|-----------------|
| Duotec fabric | 9875-Colour no. |
| Genius fabric | 9875-Colour no. |
| Stamskin Top synthetic leather | 9875-Colour no. |



Sintec fabric upholstery with lumbar pad

Soft, breathable upholstery with hard-wearing cover fabric.

Sintec synthetic leather upholstery with lumbar pad

Washable upholstery with Stamskin Top covering.

| Design | Order no. |
|--------------------------------|-----------------|
| Duotec fabric | 9876-Colour no. |
| Genius fabric | 9876-Colour no. |
| Stamskin Top synthetic leather | 9876-Colour no. |

All-In-One Highline / Trend

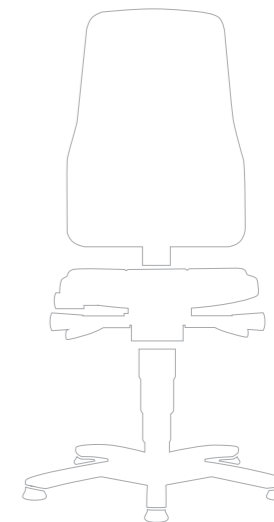

Production

The all-inclusive seating solution

The bimos All-In-One closes the gap between office chair and workplace chair. This versatile new seating solution offers all the ergonomic features you would expect in a good office chair. The concept of all-inclusive ergonomics ensures that All-in-One suits every single person and every single workplace situation, without having to make any compromise at

all. Thanks to its solid construction and tough materials, All-In-One fulfils the demands of a great many workplaces in industry, healthcare, research and development.

The All-In-One has been deliberately designed as a versatile all-rounder rather than a specialist. So it is perfect for use in places wherever people want to sit comfortably in demanding working environments. All-in-One is a chair with two heads: it is available in two design variants – Highline and Trend – to fit in with various different visual concepts.



A chair that can do everything

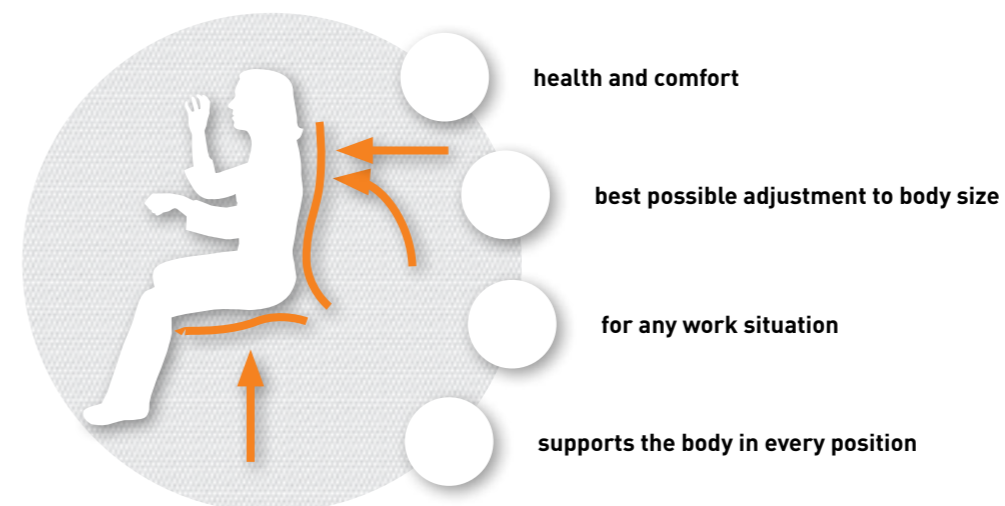

All-In-One Highline

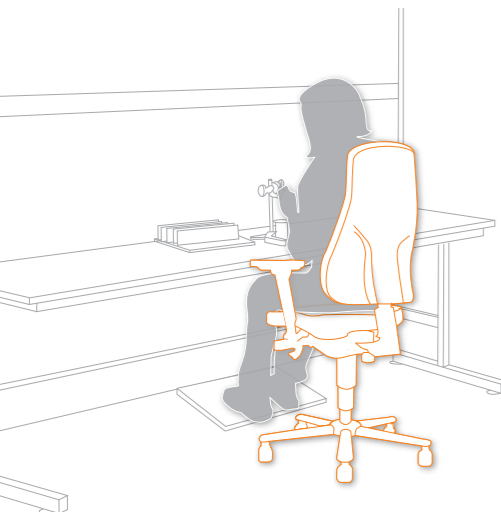

Design and materials

The All-In-One Highline is the design concept that has an especially high back. The All-In-One Highline has a stable tubular steel base with flat lines. All the steel parts are painted black. The plastic parts are black too, and extremely tough. The high version of the All-In-One Highline features a chromed foot ring that is height-adjustable, and can be used as foot support and as a mounting aid. The All-in-One Highline can be fitted either with castors with load-sensitive brakes for hard floors, or with abrasion-resistant glides. On request, the high version can also be supplied with Stop&Go castors.

Mechanisms and functions (for precise details, see pages 16-17)



Accessories (for precise details, see page 141)



Armrests are height-, depth- and width-adjustable and can be swivelled

Foot ring

Stop&Go castors

Finish and colour options for seat and backrest

| Finish | Black | Blue | Grey | Red |
|------------------------|-------|------|------|------|
| Duotec fabric | | | | |
| Order no. | 6801 | 6802 | 6811 | 6803 |
| Skai synthetic leather | | | | |
| Order no. | 2571 | 6902 | 6911 | 6903 |
| Integral foam | | | | |
| Order no. | 2000 | | | |



All-In-One Highline 1 with glides

Seat height adjustment range: 450 to 600 mm.

| Design | Order no. |
|------------------------|-----------------|
| Duotec fabric | 9640-Colour no. |
| Skai synthetic leather | 9640-Colour no. |
| Integral foam | 9640-2000 |



All-In-One Highline 2 with castors

Seat height adjustment range: 450 to 600 mm.

| Design | Order no. |
|------------------------|-----------------|
| Duotec fabric | 9643-Colour no. |
| Skai synthetic leather | 9643-Colour no. |
| Integral foam | 9643-2000 |



All-In-One Highline 3 with glides and foot ring

Seat height adjustment range: 570 to 830 mm.

| Design | Order no. |
|------------------------|-----------------|
| Duotec fabric | 9641-Colour no. |
| Skai synthetic leather | 9641-Colour no. |
| Integral foam | 9641-2000 |

All-In-One Trend



Design and materials

The All-In-One Trend is the All-In-One swivel workchair with a backrest of medium height. Its base can be supplied in black plastic or in a black painted tubular steel version. All the other steel parts are also painted black. And the tough plastic parts are finished in black. The high version of the All-In-One Trend features a chromed foot ring that is height-adjustable, and can be used as foot support and as a mounting aid. The All-in-One Trend can be fitted either with castors with load-sensitive brakes for hard floors, or with abrasion-resistant glides. On request, the high version can also be supplied with Stop&Go castors.

Mechanisms and functions (for precise details, see pages 16-17)



Accessories (for precise details, see page 141)



Armrests are height, depth and width-adjustable and can be swivelled

Foot ring

Steel base

Stop&Go castors

Finish and colour options for seat and backrest

| Finish | Black | Blue | Grey | Red |
|------------------------|-------|------|------|------|
| Duotec fabric | | | | |
| Order no. | 6801 | 6802 | 6811 | 6803 |
| Skai synthetic leather | | | | |
| Order no. | 2571 | 6902 | 6911 | 6903 |
| Integral foam | | | | |
| Order no. | 2000 | | | |



All-In-One Trend 1 with glides

Seat height adjustment range: 450 to 600 mm.

| Design | Order no. |
|------------------------|-----------------|
| Duotec fabric | 9630-Colour no. |
| Skai synthetic leather | 9630-Colour no. |
| Integral foam | 9630-2000 |



All-In-One Trend 2 with castors

Seat height adjustment range: 450 to 600 mm.

| Design | Order no. |
|------------------------|-----------------|
| Duotec fabric | 9633-Colour no. |
| Skai synthetic leather | 9633-Colour no. |
| Integral foam | 9633-2000 |



All-In-One Trend 3 with glides and foot ring

Seat height adjustment range: 570 to 830 mm.

| Design | Order no. |
|------------------------|-----------------|
| Duotec fabric | 9631-Colour no. |
| Skai synthetic leather | 9631-Colour no. |
| Integral foam | 9631-2000 |

Solitec



The robust solution for maximum flexibility

Solitec feels right at home whatever the nature of the work. That's because it combines innovative ergonomics with sturdiness and is suitable for use anywhere within

your production facilities. Special finishes and covers are available for Solitec to suit any working area. The integrated seat tilt function ensures a high standard of ergonomics even when the user has to lean forwards.



Production

The right finish for any application

Solitec offers the perfect finishes and coverings to meet the requirements of any workplace scenario:



Wood finish

Laminated beech. Highly robust, washable and resistant to oil and grease.

Fabric upholstery

This soft, breathable upholstery with its hard-wearing cover fabric is sheer luxury.

Integral foam upholstery

This high-comfort upholstery is resistant to oil, grease and flying sparks and can withstand mech.influences. It's washable and extremely hard-wearing.

Skai synthetic leather

This non-slip, non-tear covering provides a soft and comfortable feel and is also washable.

A true survivor

Solitec is extremely sturdy and highly durable. The backrest link is made from robust flat steel and the 5 star base from sectional steel tubing. The edge protector that runs all the way round provides effective protection for the upholstery.

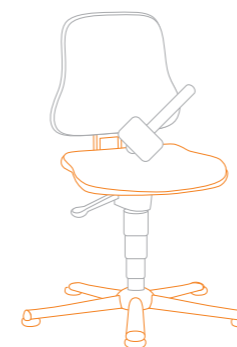

Solitec

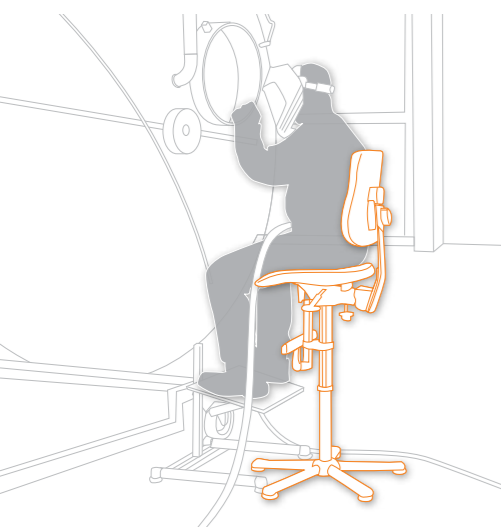

Design and materials

Solitec features a sturdy, five-legged base frame with flat lines made from sectional steel tubing. All the metal components are epoxy-resin coated. All Solitec models are supplied with an anthracite frame. The 5 star base can be supplied with special castors featuring load-sensitive brakes for hard floors (Solitec 2) or with abrasion-resistant glides (Solitec 1 and Solitec 3) as an option.

Mechanisms and functions (for precise details, see pages 16-17)

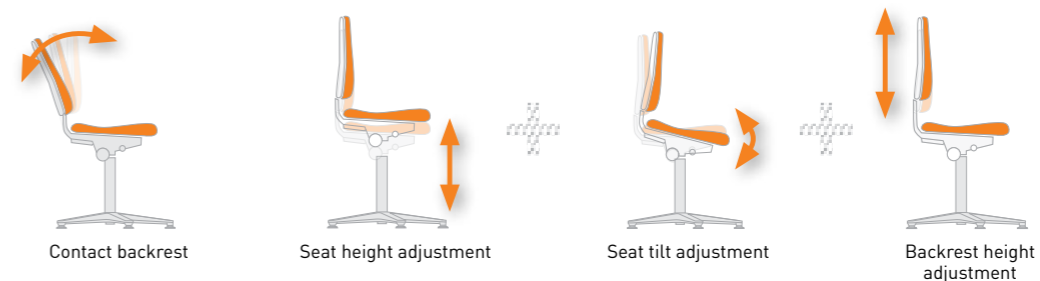

Accessories (for precise details, see page 141)



Ring-shaped armrest Multifunction armrest Swivel lock Foot ring

Options



Disc base Polished aluminium base

Upholstery finish and colour options

| Finish | Black | Blue | Grey | Red | Natural |
|------------------------|-------|------|-----------------|------|---------|
| Duotec fabric | | | | | |
| Order no. | 6801 | 6802 | 6811 | 6803 | |
| Skai synthetic leather | | | | | |
| Order no. | 2571 | 6902 | 6911 | 6903 | |
| Integral foam | | | Laminated beech | | |
| Order no. | 2000 | | | 3000 | |



Solitec 1 with glides

Seat height adjustment range: 440 to 590 mm.

| Design | Order no. |
|------------------------|-----------------|
| Laminated beech | 9203-3000 |
| Duotec fabric | 9203-Colour no. |
| Skai synthetic leather | 9203-Colour no. |
| Integral foam, black | 9203-2000 |



Solitec 2 with castors

Seat height adjustment range: 440 to 590 mm.

| Design | Order no. |
|------------------------|-----------------|
| Laminated beech | 9208-3000 |
| Duotec fabric | 9208-Colour no. |
| Skai synthetic leather | 9208-Colour no. |
| Integral foam, black | 9208-2000 |



Solitec 3 with glides and step

Seat height adjustment range: 600 to 875 mm.

| Design | Order no. |
|------------------------|-----------------|
| Laminated beech | 9213-3000 |
| Duotec fabric | 9213-Colour no. |
| Skai synthetic leather | 9213-Colour no. |
| Integral foam, black | 9213-2000 |

Isitec



The practical solution for everyday use

There are no airs and graces with Isitec whether faced with swarf, oil or shavings, Isitec will show you what a good industrial chair is capable of. The hard-wearing SoftTouch integral foam provides amazing softness and is a pleasure to sit on. Furthermore, Isitec is easy to clean, and is resistant to disinfectants.



SoftTouch integral foam

SoftTouch integral foam, which is still fresh from the drawing board, provides the ultimate in softness, and is washable and resistant to external influences.

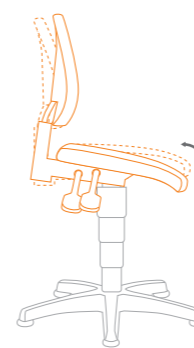

Easily adjustable

Isitec has all the essential qualities of a good workplace chair. All the adjustment functions allow for quick and easy operation via levers while the user is sitting down. The fact that the functions are labelled makes finding the right lever child's play. The continuously variable tilt adjustment function, which can be used to tilt the seat forwards by up to 8° ensures a minimum seat angle of 90° even when leaning forward into the work.

Isitec

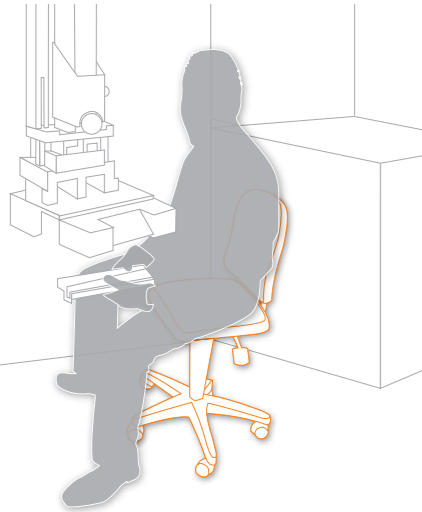

Design and materials

Isitec features a sturdy, five-legged base frame with flat lines made from plastic. All Isitec models are supplied with a black frame. The chrome-plated foot ring has a particularly wide tread and is height-adjustable. Isitec can be supplied with special castors featuring load-sensitive brakes for hard floors (Isitec 2) or with abrasion-resistant glides (Isitec 1 and Isitec 3) as an option.

Mechanisms and functions (for precise details, see pages 16-17)

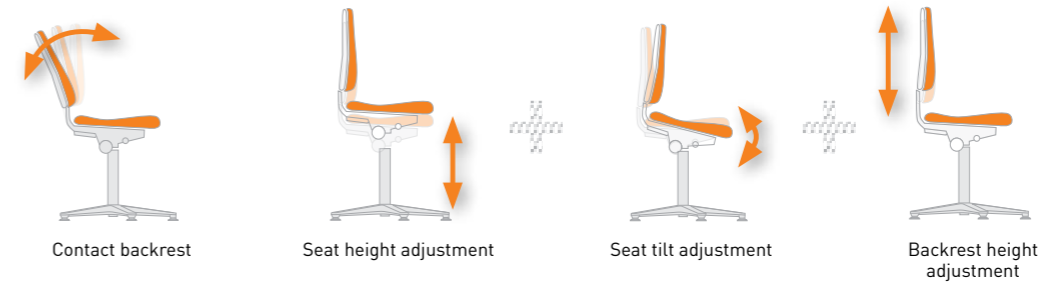

Options



Steel 5 star base

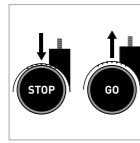

Stop&Go castors

Accessories (for precise details, see page 141)



Ring-shaped armrest



Multifunction armrest



Foot ring

Upholstery finish and colour options

Finish **Black**

Integral foam



Order no.

2000



Isitec 1 with glides

Seat height adjustment range: 430 to 600 mm.

Design

Integral foam, black

Order no.

9603-2000



Isitec 2 with castors

Seat height adjustment range: 430 to 600 mm.

Design

Integral foam, black

Order no.

9608-2000



Isitec 3 with glides and foot ring

Seat height adjustment range: 580 to 850 mm.

Design

Integral foam, black

Order no.

9613-2000

Unitec



The low-cost solution for solid performance

Unitec is our low-cost entry model for healthy sitting in a production context. The contact backrest, which is supplied as standard, provides support when working sitting down.

The generously proportioned seat and backrest provide additional support. There is a choice of various coverings to ensure that Unitec will fit in visually with practically any working environment. Consequently, Unitec is a good solid chair for almost any application.

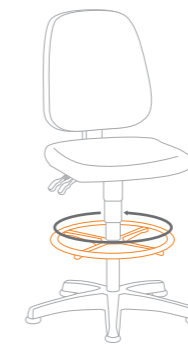

Foot ring

The chrome-plated foot ring provides a firm foothold thanks to its wide tread and can be quickly and easily adjusted in terms of its height.



Standard functions for first-time buyers

- Seat height adjustment
- Backrest height adjustment
- Contact backrest

Unitec

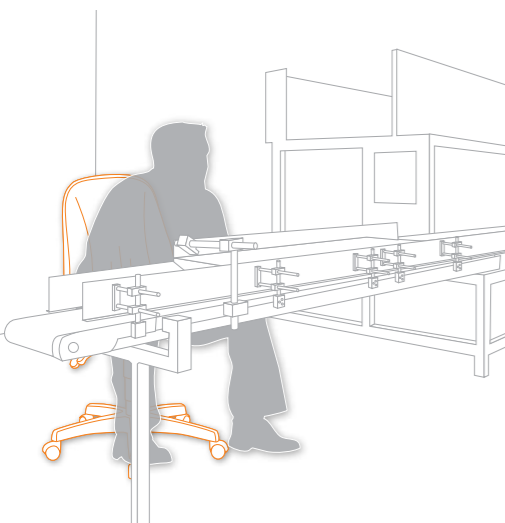

Design and materials

Unitec features a sturdy, five-legged base frame with flat lines made from plastic. All Unitec models are supplied with a black base frame. The chair can be supplied with special castors featuring load-sensitive brakes for hard floors (Unitec 2) or with abrasion-resistant glides (Unitec 1 and Unitec 3) as an option. The Unitec seat and backrest are very generously proportioned in the case of the fabric and synthetic leather versions.

Mechanisms and functions (for precise details, see pages 16-17)



Accessories (for precise details, see page 141)



Multifunction armrest (not available with wood version)
 Ring-shaped armrest
 Foot ring

Upholstery finish and colour options

| Finish | Black | Blue | Natural |
|-------------------|-------|------|---------|
| Laminated beech | | | |
| Order no. | | | 3000 |
| Fabric | | | |
| Order no. | 1101 | 1103 | |
| Synthetic leather | | | |
| Order no. | 0551 | 0562 | |
| Integral foam | | | |
| Order no. | 2000 | | |



Unitec 1 with glides

Seat height adjustment range: 440 to 620 mm.

| Design | Order no. |
|----------------------|-----------------|
| Laminated beech | 9650-3000 |
| Fabric | 9650-Colour no. |
| Synthetic leather | 9650-Colour no. |
| Integral foam, black | 9650-2000 |



Unitec 2 with castors

Seat height adjustment range: 440 to 620 mm.

| Design | Order no. |
|----------------------|-----------------|
| Laminated beech | 9653-3000 |
| Fabric | 9653-Colour no. |
| Synthetic leather | 9653-Colour no. |
| Integral foam, black | 9653-2000 |



Unitec 3 with glides and step

Seat height adjustment range: 580 to 850 mm.

| Design | Order no. |
|----------------------|-----------------|
| Laminated beech | 9651-3000 |
| Fabric | 9651-Colour no. |
| Synthetic leather | 9651-Colour no. |
| Integral foam, black | 9651-2000 |

Stools

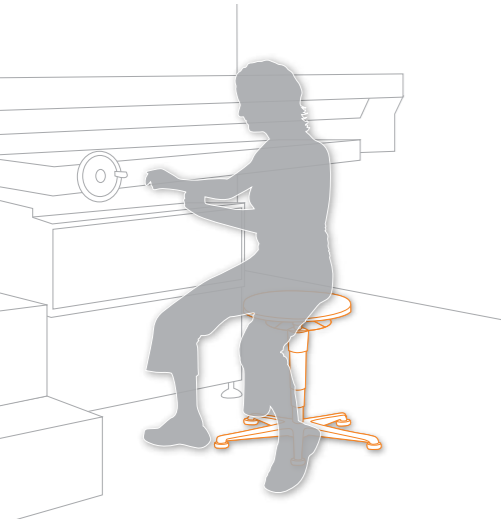

Industrious assistants

With their extra-large 40 cm diameter seats, these hard-wearing stools provide optimum support in industrial and workshop applications. The sturdy steel 5 star base and upholstery edge protector that runs all the way round guarantee a long lifespan. The practical pneumatic spring system with easy ring control allows for comfortable seat height adjustment.

Functions (for precise details, see pages 16-17)

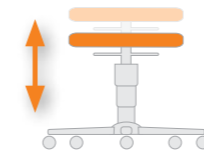

Seat height adjustment based on pneumatic spring system with easy ring control

Options



Polished aluminium 5 star base

Finish and colour options for seat

| Finish | Black | Blue | Grey | Red | Natural |
|--------------------------------|-------|------|------|------|---------|
| Duotec fabric | | | | | |
| Order no. | 6801 | 6802 | 6811 | 6803 | |
| Stamskin Top synthetic leather | | | | | |
| Order no. | 4524 | 4523 | 4521 | 4508 | |
| Integral foam | | | | | |
| Order no. | 2000 | | | | |
| Laminated beech | | | | | |
| Order no. | | | | | 3000 |



Stool 1 with glides

Seat height adjustment range: 460 to 630 mm.

| Design | Order no. |
|--------------------------------|-----------------|
| Laminated beech | 9467-3000 |
| Duotec fabric | 9467-Colour no. |
| Stamskin Top synthetic leather | 9467-Colour no. |
| Integral foam, black | 9467-2000 |



Stool 2 with castors

Seat height adjustment range: 460 to 630 mm.

| Design | Order no. |
|--------------------------------|-----------------|
| Laminated beech | 9468-3000 |
| Duotec fabric | 9468-Colour no. |
| Stamskin Top synthetic leather | 9468-Colour no. |
| Integral foam, black | 9468-2000 |



Stool 3 with glides and foot ring

Seat height adjustment range: 570 to 850 mm.

| Design | Order no. |
|--------------------------------|-----------------|
| Laminated beech | 9469-3000 |
| Duotec fabric | 9469-Colour no. |
| Stamskin Top synthetic leather | 9469-Colour no. |
| Integral foam, black | 9469-2000 |

Footrests

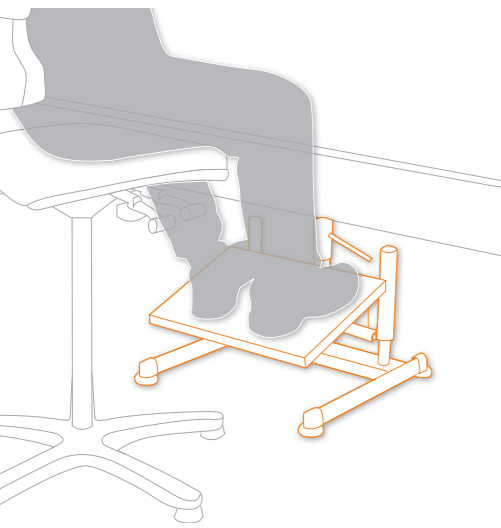

Support in your everyday work

In the case of elevated seating positions, footrests can provide the necessary support for your legs. They can be used to ensure exactly the right angle between your thigh and upper body. That is why the EEC directive governing the minimum health and safety requirements for the workplace specifies the following: "When seated, the employee's feet must be in contact with the floor or a footrest". bimos industrial footrests are really easy to adjust for the individual concerned, enable the user to adopt the correct posture and thereby ensure good thigh circulation. The non-slip rubber tread provides a firm grip even when the work is physically demanding.

Model 9455 functions

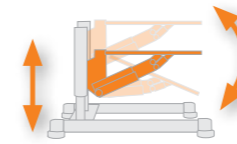

Pedal buttons enable convenient footrest adjustment while seated

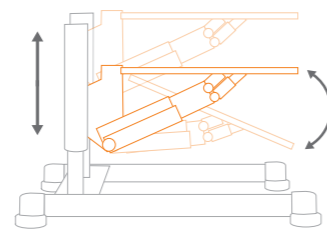

Perfect adaptability

All bimos footrests feature continuously variable height and tilt angle adjustment. This means that the footrests can be perfectly adapted to any workplace situation. In the case of Model 9455, this is achieved by means of a pneumatic spring, making your footrest as convenient and easy to adjust as the familiar modern workplace chair.



Industrial footrest with pneumatic spring

Non-slip rubber tread.
Height adjustment range: 100 to 340 mm.
Tilt adjustment range: 8° to 25°.
Tread dimensions: 440 x 340 mm.

| Design | Order no. |
|------------|-----------|
| Anthracite | 9455 |



Industrial footrest with clamp lever

Non-slip rubber tread.
Height adjustment range: 65 to 410 mm.
Tilt adjustment range: 8° to 25°.
Tread dimensions: 440 x 340 mm.

| Design | Order no. |
|------------|-----------|
| Anthracite | 9450 |

Sintec 160



The workchair for people up to 160 kg

We have made it our mission to provide the right workplace chair for absolutely everybody. And that applies to also to very heavy people. The Sintec 160 is the ideal solution for these people. Sintec 160 gives heavy people all the same positive seating features that are available in the standard version of Sintec. All the components are specially designed for particularly heavy loads. Its broad-based construction does not constrain Sintec 160 at all, and gives heavy people plenty of room to move around. Sintec 160 has a polished aluminium base. The width of the optional ring armrests is adjustable. Sintec 160 has the same replaceable upholstery system as Sintec.

Mechanisms and functions (for precise details, see pages 16-17)



Accessories (for precise details, see page 141)



Ring-shaped armrest

Upholstery finish and colour options

| Finish | Black | Blue | Grey | Red |
|--------------------------------|-------|------|------|------|
| Genius fabric | | | | |
| Order no. | GE01 | GE02 | GE11 | |
| Stamskin Top synthetic leather | | | | |
| Order no. | 4524 | 4523 | 4521 | 4508 |
| Integral foam | | | | |
| Order no. | 2000 | | | |

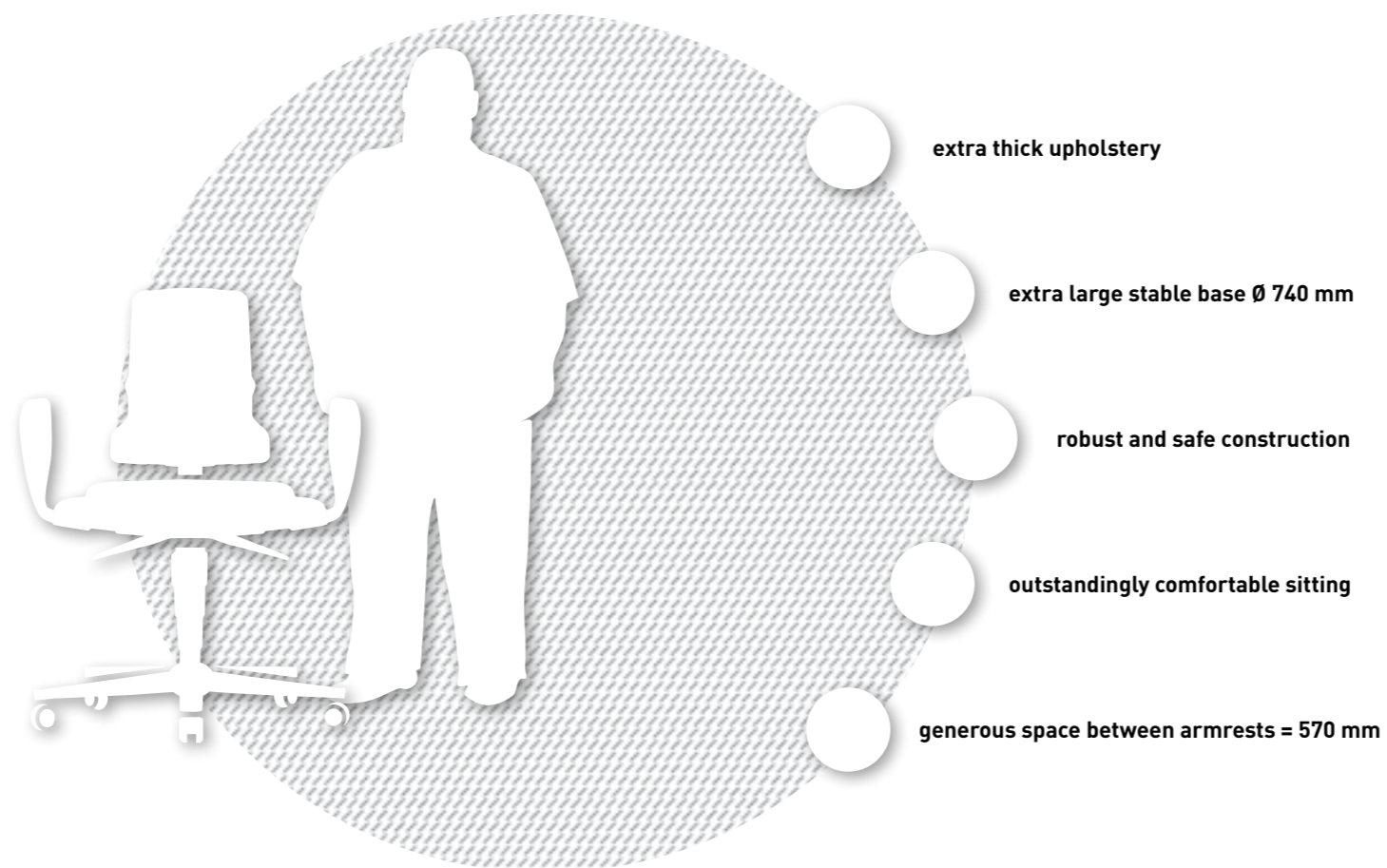

Armrest optional



Sintec 160 including glides and castors

Seat height adjustment range: 490 to 640 mm.
(with glides 450 to 600 mm)

| Design | Order no. |
|--------------------------------|-----------------|
| Genius fabric | 9816-Colour no. |
| Stamskin Top synthetic leather | 9816-Colour no. |
| Integral foam | 9816-2000 |

24h Chair



The high-flier that never takes a break

The 24h Chair remains in use around the clock and must constantly adapt to the needs of different workers and different situations. It has been perfectly designed with this in mind, as it is a versatile and robust chair that provides the user with the support he or she needs in any situation, e.g. on the basis of its multifunctional armrests and numerous adjustment options. The replaceable upholstery, which is available in a wide range of finishes and colours, is an additional bonus. What's more, the 24h Chair is the ideal seating solution for people with a heavy frame.

Mechanisms and functions (for precise details, see pages 16-17)



Options



- Excellent performance at a glance:**
- Reinforced mechanical system and 5 star base
 - All upholstery can be removed and replaced
 - The Genius fabric is 10 times more hard-wearing than conventional upholstery fabrics
 - Integral foam jacket for protection against impacts
 - Armrests are proportionally height, depth and width-adjustable and can also be pivoted
 - Suitable for body weights of up to 180 kg

Accessories (for precise details, see page 141)



Upholstery finish and colour options

| Finish | Black | Blue | Grey | Red |
|--------------------------------|-------|------|------|------|
| Duotec fabric | | | | |
| Order no. | 6801 | 6802 | 6811 | 6803 |
| Genius fabric | | | | |
| Order no. | GE01 | GE02 | GE11 | |
| Stamskin Top synthetic leather | | | | |
| Order no. | 4524 | 4523 | 4521 | 4508 |



Picture: with armrests

24h Swivel Chair

Seat height adjustment range: 420 to 510 mm.

| Design | Order no. |
|-------------------------|-----------------|
| Stoff Duotec | 9335-Colour no. |
| Stoff Genius | 9335-Colour no. |
| Kunstleder Stamskin Top | 9335-Colour no. |



Picture: with armrests

24h Swivel Chair with neck support

Seat height adjustment range: 420 to 510 mm.

| Design | Order no. |
|-------------------------|-----------------|
| Stoff Duotec | 9336-Colour no. |
| Stoff Genius | 9336-Colour no. |
| Kunstleder Stamskin Top | 9336-Colour no. |



ESD area

**“In the ESD workplace
it comes down
to relieving tension.”**

ESD area

Reliable electrostatic discharge protection for electronic workstations

ESD (Electro Static Discharge) refers to the electrostatic discharge of charged objects or people. Electrostatic discharge can result in damage to microelectronics components. This is because of the minute scale involved which means that the energy from a static discharge has the same impact on a semiconductor as a lightning strike would on a tree. ESD chairs play a crucial role when it comes to ensuring reliable ESD protective measures for electronic workstations.

ESD protection is regulated by European standard EN 61340, which is designed to help users select appropriate protective measures. It stipulates the following in respect of workplace chairs: "The resistance to the point of contact with the floor of any parts of the seat that could come into contact with the user's body during standard use must be $<10^{10} \Omega$." (Extract from standard EN 61340-5-1)

| Discharge resistance | Acc. to EN 61340-5-1 | bimos ESD chairs |
|----------------------|----------------------|------------------|
| Workplace chair | $<10^{10} \Omega$ | $10^6 \Omega$ |
| Surface resistance | Acc. to EN 61340-5-1 | bimos ESD chairs |
| Workplace chair | - | $10^6 \Omega$ |

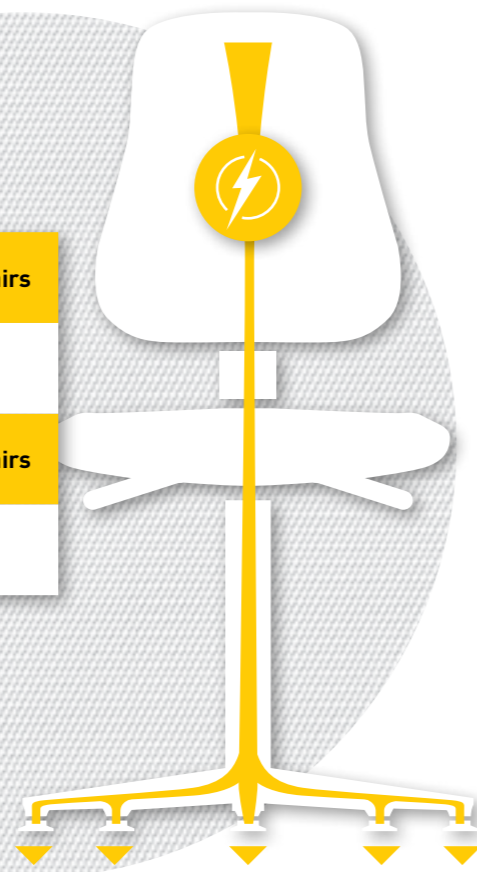

All-round safety: the unique bimos ESD protection features

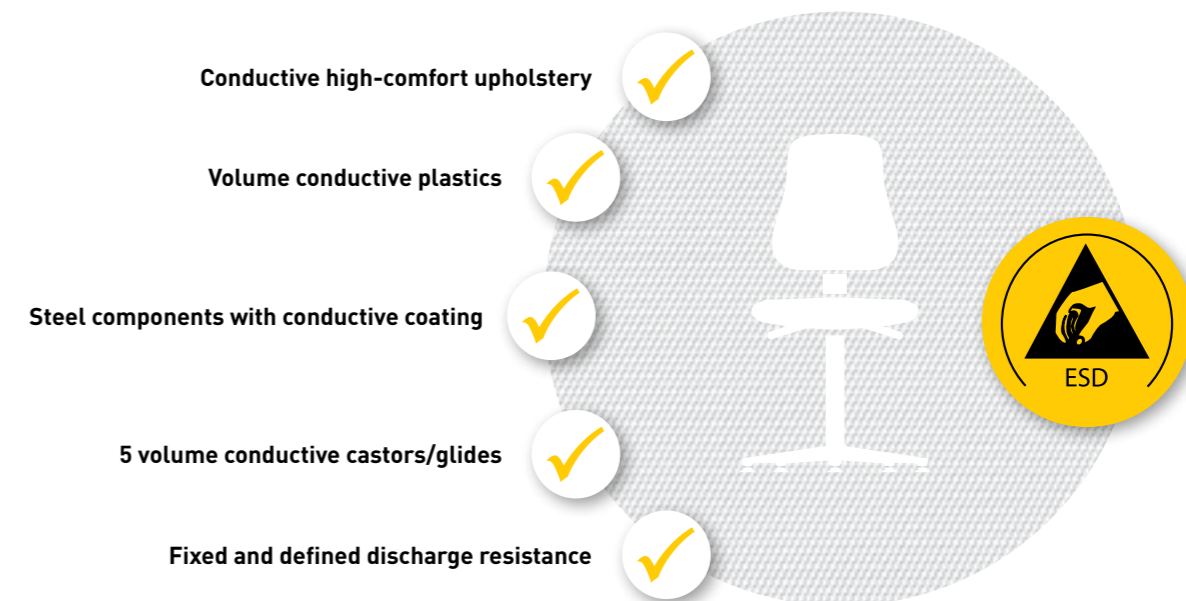

Consistently exceeding the standard

bimos ESD chairs meet the requirements of standard EN 61340-5-1 as far as their use in EPAs (ESD Protected Areas) is concerned. However, the demands that actually apply in practice are often more stringent even than this. This is because the increasing miniaturisation of electronics components is making them more susceptible to the problem of electrostatic discharge. The most effective way of dealing with this issue is either to prevent charges from occurring in the first place or to ensure that any undesirable charges are safely discharged.

Thanks to the optimum choice of materials and connection technology used, bimos chairs reliably prevent the build-up of electrostatic charges. In addition, the chairs are designed to direct any charges that the user may be carrying safely down to the conductive base as soon as he or she sits down. Thus, bimos ESD chairs offer a fully integrated system of protection.

ESD Neon

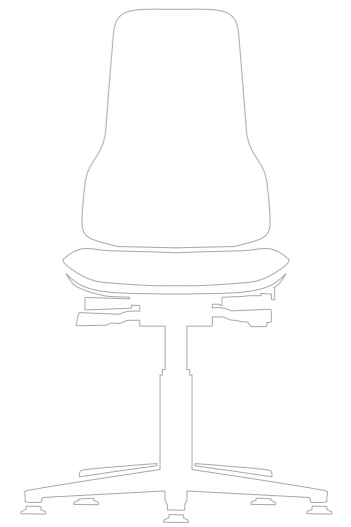

New generation workchairs

Neon is probably the best workplace chair for ESD areas. Like all bimos ESD chairs, it far exceeds the requirements of the ESD standard EN 61340-5-1. In addition to its outstanding key technical features, the ESD Neon has one characteristic that until now has not been found in the ESD working environment: a focus on the human being. As the most ergonomic and most

comfortable ESD chair available, Neon forms a bridge between uncompromising technical demands and enjoyment in sitting. The workplace is an indicator of the value a company places on its employees. A chair that focuses on the needs of people helps to orientate and motivate, it raises the quality and productivity of work. ESD workplaces are always to be found in high-tech companies. This contemporary aspect is also reflected in Neon's design. For the first time with the ESD Neon, a chair is at last available that is really in tune with the work that is carried out on it. ESD Neon is the new generation workplace chair for the new generation of work.



The characteristics of the bimos ESD protection system

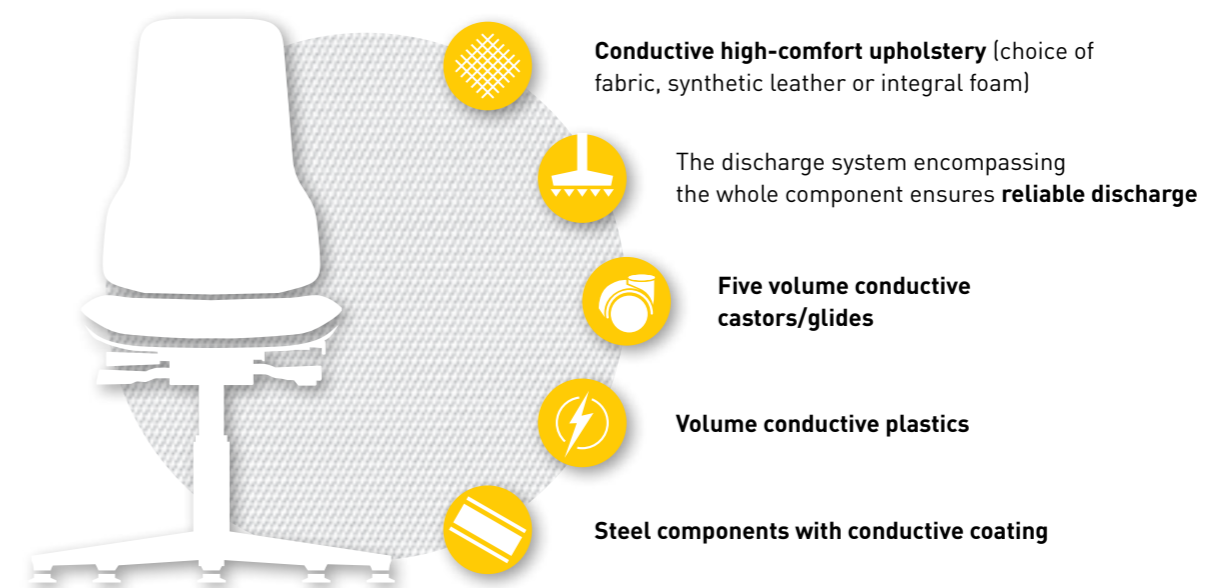

ESD Neon

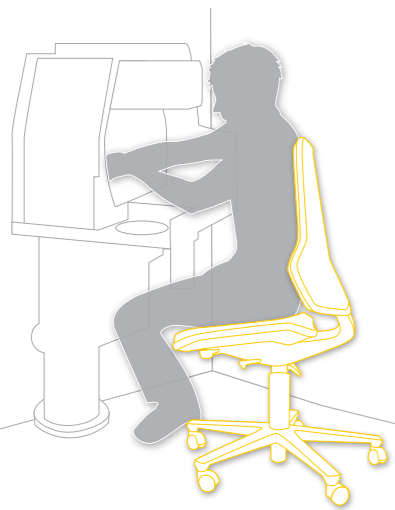

Design and materials

All the plastic and metal parts in ESD Neon are black. The reason for this is because they are conductive, as is every component in the Neon. Plastic too is coated with carbon particles to make it conductive. The most striking feature of ESD Neon is its flex strip. It is made of soft plastic and protects the chair and its environment. There is a choice of three colours for the flex strip. The chair itself consists of solid steel with an aluminium base. Neon is available with a choice of castors with load-sensitive brakes for hard floors, or with abrasion-resistant glides. In addition, for the high version optional Stop&Go castors are available. All glides and castors are volume conductive.

Mechanisms (for precise details, see pages 16-17)

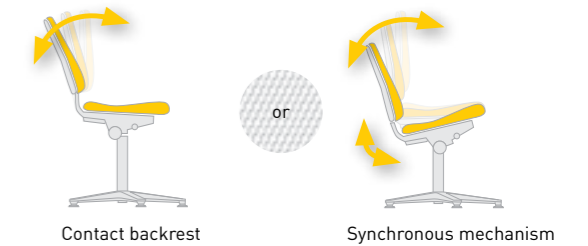

Ergonomics package (for precise details, see pages 16-17)

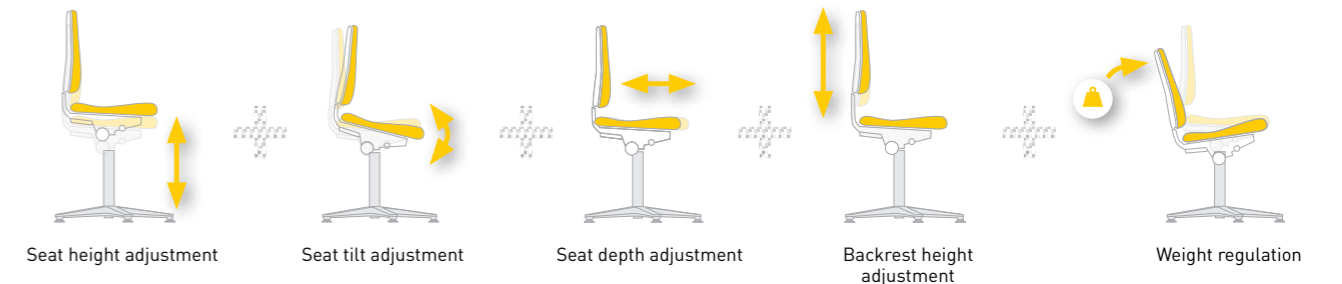

Options



Polished aluminium
5 star base

Accessories (for precise details, see page 141)



Multifunction
ESD armrest

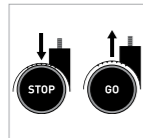

ESD Stop&Go
castors



ESD Neon 1 with glides

Seat height adjustment range: 450 to 620 mm.

| Design | Order no. |
|--|-------------------------|
| Permanent contact inc. ergonomics package | 9560E-Flex strip colour |
| Synchronous technology inc. ergonomics package | 9570E-Flex strip colour |



ESD Neon 2 with castors

Seat height adjustment range: 450 to 620 mm.

| Design | Order no. |
|--|-------------------------|
| Permanent contact inc. ergonomics package | 9563E-Flex strip colour |
| Synchronous technology inc. ergonomics package | 9573E-Flex strip colour |



ESD Neon 3 w. mounting aid and glides

Seat height adjustment range: 590 to 870 mm.

| Design | Order no. |
|--|-------------------------|
| Permanent contact inc. ergonomics package | 9561E-Flex strip colour |
| Synchronous technology inc. ergonomics package | 9571E-Flex strip colour |

Flex strip colour

| | Happy orange | Mars green | Cool grey |
|------------|--------------|------------|-----------|
| Flex strip | | | |
| Order no. | 3279 | 3280 | 3278 |

ESD Neon

Design and materials

A ESD Neon always consists of two basic elements: the chair and the upholstery. The innovative 1+1 system of ESD Neon allows you to change the upholstery with a single click, so that it adapts to any particular work environment. With the 1+1 system, you order chair and upholstery elements separately (please note that you can only sit on the chair with an upholstery element).

In spite of the high technical demands on material properties in the ESD area, there are three different upholstery variations available for ESD Neon: tough integral foam upholstery which is able to withstand mechanical damage, easy-care synthetic leather that is soft and washable, and robust and breathable fabric upholstery.

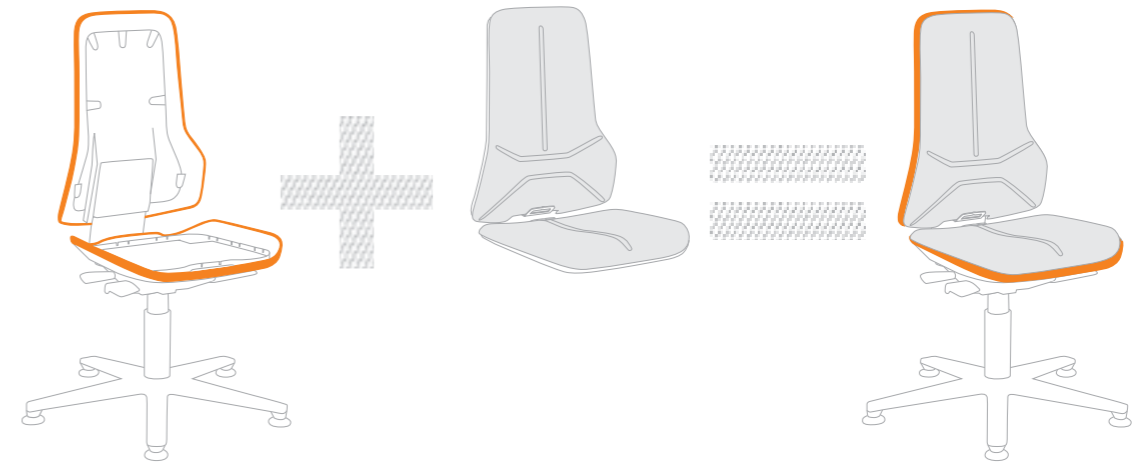

Upholstery finish and colour options

| Finish | Black | Blue | Grey |
|-------------------------|-------|------|------|
| Taff fabric | | | |
| Order no. | TL01 | TL02 | TL11 |
| Magic synthetic leather | | | |
| Order no. | MG01 | | |
| Integral foam | | | |
| Order no. | 2000 | | |



ESD Neon fabric upholstery

breathable, comfortable, soft, hard-wearing

| Design | Order no. |
|-------------|------------------|
| Taff fabric | 9588E-Colour no. |



ESD Neon synthetic leather upholstery

washable, easy-care, soft and comfortable

| Design | Order no. |
|-------------------------|------------|
| Magic synthetic leather | 9588E-MG01 |



ESD Neon integral foam upholstery

extremely robust, durable, washable, able to withstand mechanical damage, resistant to mild acids and alkalis

| Design | Order no. |
|---------------|------------|
| Integral foam | 9588E-2000 |

ESD Sintec

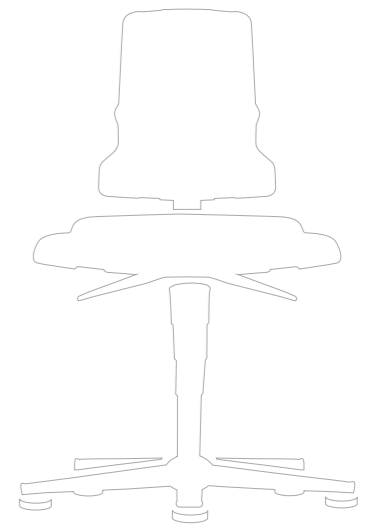

The tried and tested solution for custom seating

ESD Sintec is characterised by its excellent ESD protection properties for maximum reliability: It is manufactured using volume conductive materials and features conductive surfaces. Its superb ergonomic design and individual functions

make it the ideal chair for any workplace scenario. ESD Sintec combines perfect support for your workplace tasks with a high level of comfort. The backrest is tapered towards the top, thereby providing more space for moving your arms around. ESD Sintec's replaceable upholstery elements provide maximum flexibility. It is the combination of all these factors that makes ESD Sintec our best selling ESD chair.



The characteristics of the bimos ESD protection system

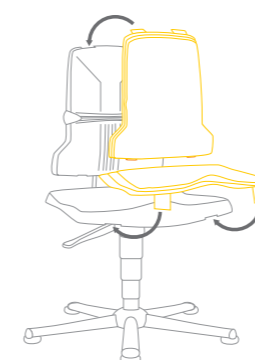
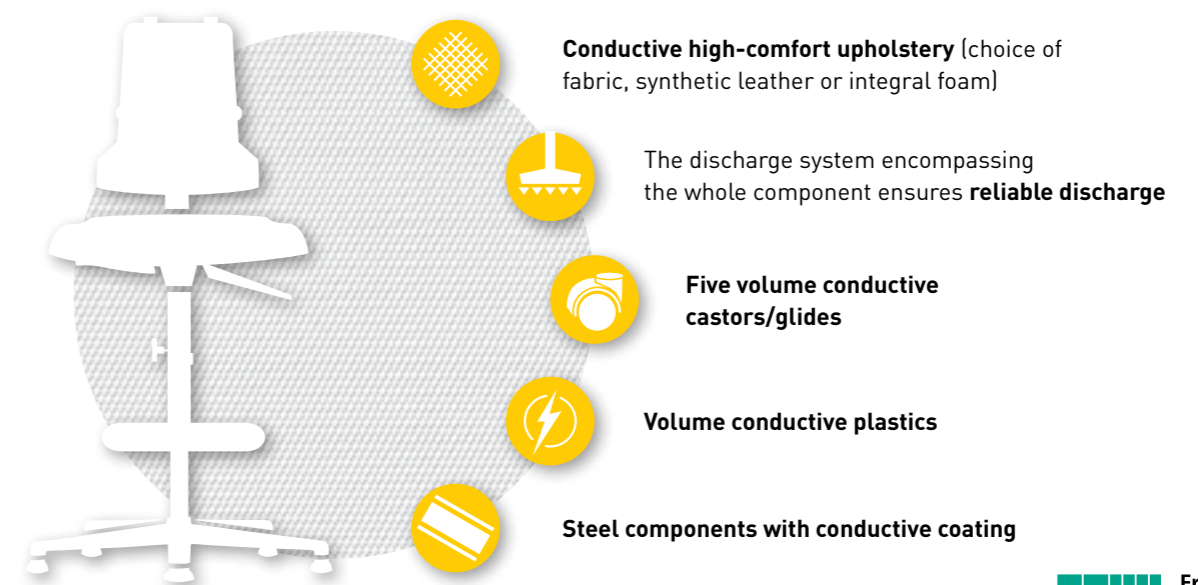

Easily replaceable seat and backrest upholstery

Various conductive seat and backrest upholstery options are available for ESD Sintec, enabling chairs to be perfectly adapted for any working environment. Changing the upholstery couldn't be easier thanks to the quick and convenient hook-on concept.



ESD Sintec



Design and materials

ESD Sintec is equipped with seat and backrest shells made from volume conductive plastic. The conductive quick-change upholstery means that you can tailor this ESD chair to create the look you want. The chair features a sturdy five-legged base frame with flat lines, which is made from sectional steel tubing. This offers great stability as well as highly reliable electrostatic discharge. All ESD Sintec models are supplied with a black frame.

Mechanisms and functions (for precise details, see pages 16-17)

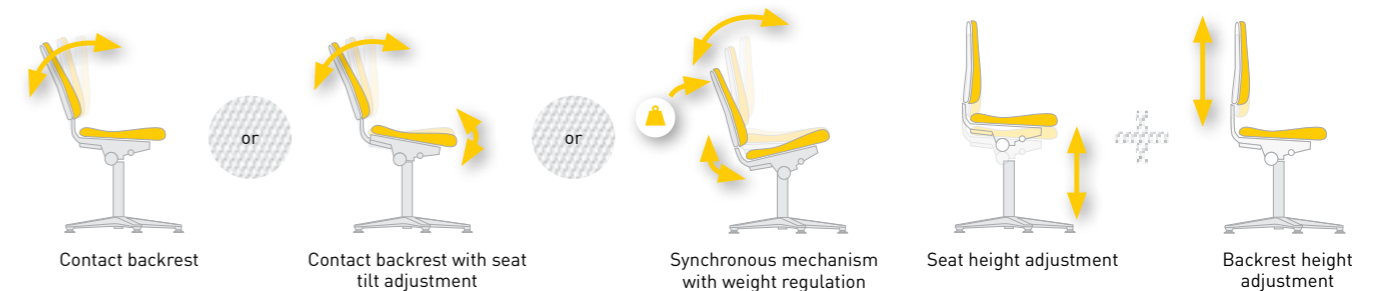

Options

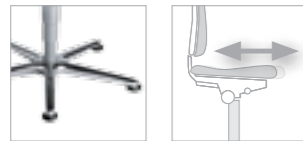

Polished aluminium 5 star base

Seat depth adjustment

Accessories (for precise details, see page 141)



Ring-shaped armrest

ESD multifunction armrest

Foot ring

Carry handle

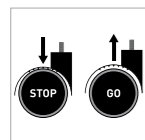

ESD Stop&Go castors



ESD Sintec 1 with glides

Seat height adjustment range: 430 to 580 mm.

| Design | Order no. |
|--|------------|
| Contact backrest | 9800E-1100 |
| Contact backrest with tilting seat | 9810E-1100 |
| Synchronous mechanism with weight regulation | 9820E-1100 |



ESD Sintec 2 with castors

Seat height adjustment range: 430 to 580 mm.

| Design | Order no. |
|--|------------|
| Contact backrest | 9803E-1100 |
| Contact backrest with tilting seat | 9813E-1100 |
| Synchronous mechanism with weight regulation | 9823E-1100 |



ESD Sintec 3 with glides and step

Seat height adjustment range: 580 to 850 mm.

| Design | Order no. |
|--|------------|
| Contact backrest | 9801E-1100 |
| Contact backrest with tilting seat | 9811E-1100 |
| Synchronous mechanism with weight regulation | 9821E-1100 |

ESD Sintec

Design and materials

Depending on where they are going to be used, all ESD Sintec workplace chairs can be fitted with fabric, synthetic leather or hard-wearing integral foam upholstery. The upholstery is switched over using a simple hook-on system. This innovative, yet straightforward principle means that you can adapt the chair to the individual workplace scenario. All ESD Sintec replaceable upholstery provides a luxurious level of comfort and offers superb ESD characteristics.

ESD Sintec replaceable upholstery

- Conductive
- Quick and easy to attach thanks to the hook-on system
- Can be changed at any time
- Improves the workplace's unique appeal and its flexibility
- Increases seat height by 20 mm

Functions



Upholstery with lumbar pad: Provides exceptional support for your lumbar region.

Upholstery finish and colour options

| Finish | Black | Blue | Grey | Red |
|----------------------------|-------|------|------|------|
| Duotec ESD fabric | | | | |
| Order no. | 9801 | 9802 | 9811 | 9803 |
| Skai ESD synthetic leather | | | | |
| Order no. | 2571 | | | |
| ESD integral foam | | | | |
| Order no. | 2000 | | | |



ESD Sintec integral foam upholstery

Easy-care, washable and robust covering, resistant to mild acids and alkalis and capable of withstanding mechanical influences. Structured surface for optimum climatic comfort.

| Design | Order no. |
|--------------------------|------------|
| ESD integral foam, black | 9865E-2000 |



ESD Sintec fabric upholstery

Soft, breathable upholstery consisting of hard-wearing cover fabric.

ESD Sintec synthetic leather upholstery

Non-slip, non-tear Stamskin Top upholstery

| Design | Order no. |
|-----------------------------------|------------------|
| Duotec ESD fabric | 9875E-Colour no. |
| Skai ESD synthetic leather, black | 9875E-2571 |



ESD Sintec fabric upholst. with lumb. pad

Soft, breathable upholstery consisting of hard-wearing cover fabric.

ESD Sintec synth. leath. upholst. with lumb. pad

Non-slip, non-tear Stamskin Top upholstery.

| Design | Order no. |
|-----------------------------------|------------------|
| Duotec ESD fabric | 9876E-Colour no. |
| Skai ESD synthetic leather, black | 9876E-2571 |

ESD Basic

The tried-and-tested all-rounder for use in ESD areas

ESD Basic is the low-cost ESD model from bimos which provides excellent value for money: With its ergonomic design, high standard of user comfort and reliable ESD protection

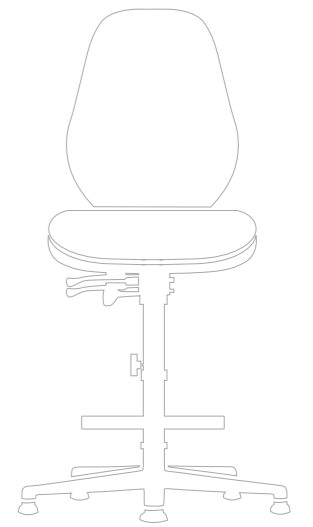

system that ensures a discharge resistance in accordance with EN 61340-5-1, it has all the essential attributes of a high-performance workplace chair that has been designed specifically for the electronics industry.



The characteristics of the bimos ESD protection system

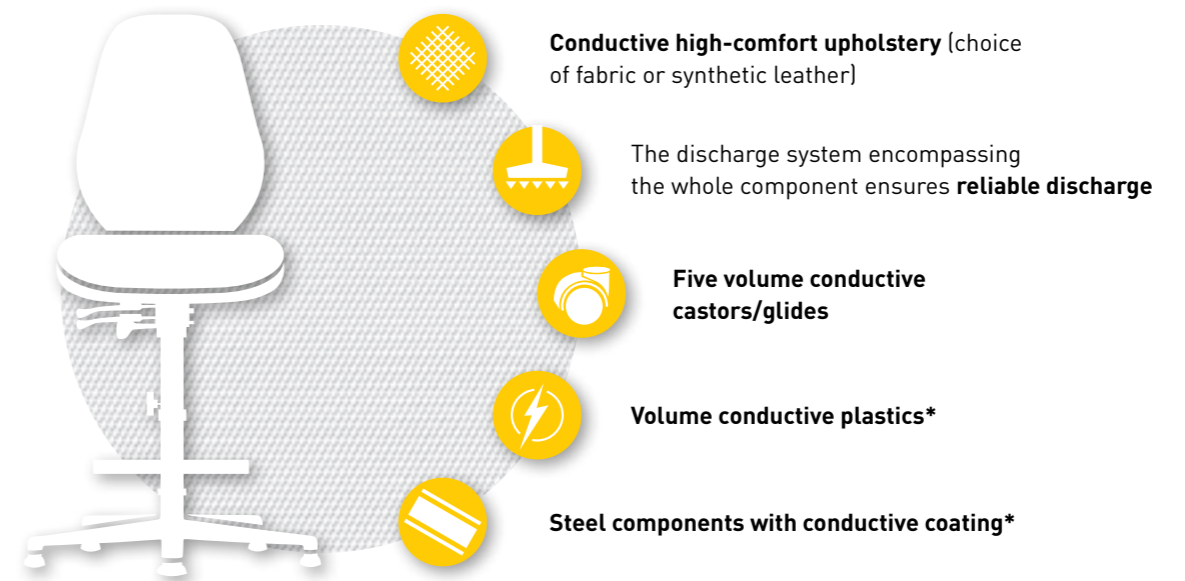

* These features only apply in the case of the ESD plus option.

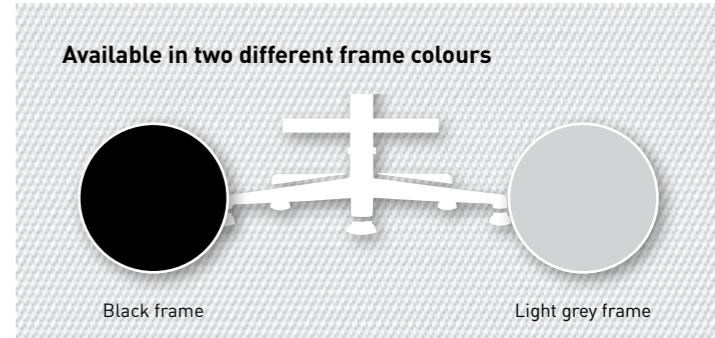

ESD Basic

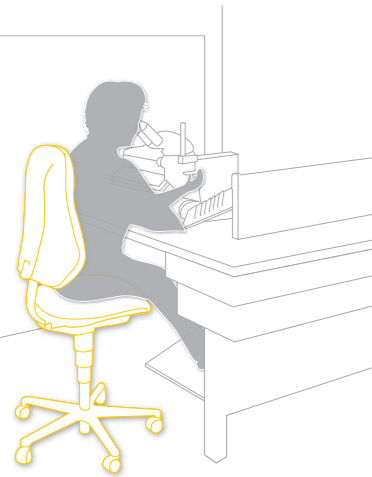

Design and materials

ESD Basic has conductive covers. It features a sturdy five-legged base frame with flat lines, which is made from epoxy-resin coated sectional steel tubing and provides good stability. The frame is available in either black or light grey.

Mechanisms and functions (for precise details, see pages 16-17)

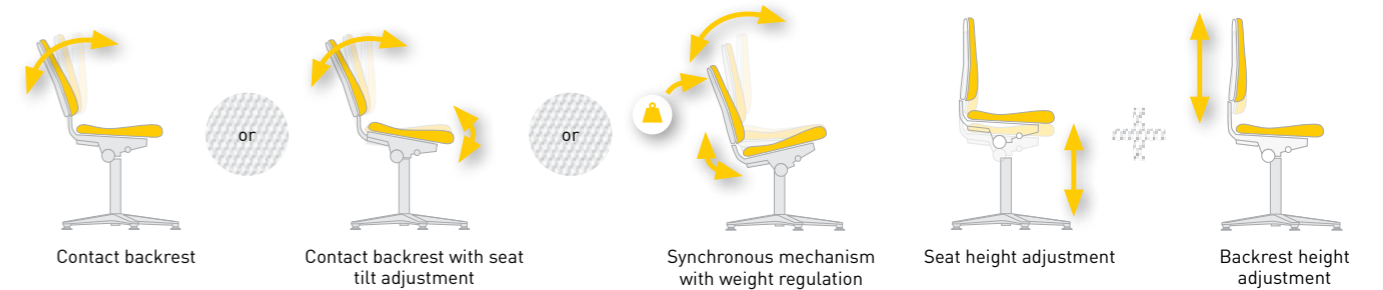

Options



Polished aluminium 5 star base Light grey frame ESD plus option

Accessories (for precise details, see page 141)



Ring-shaped armrest, black Ring-shaped armrest, light grey ESD multi-function armrest Foot ring

Upholstery finish and colour options

Finish Black Blue Grey Red

| | | | | |
|-------------------|------|------|------|------|
| Duotec ESD fabric | | | | |
| Order no. | 9801 | 9802 | 9811 | 9803 |

| | |
|----------------------------|------|
| Skai ESD synthetic leather | |
| Order no. | 2571 |



ESD Basic 1 with glides

Seat height adjustment range*: 470 to 610 mm.

| Design | Height of backrest | Order no. |
|--|--------------------|------------------|
| Contact backrest | 430 mm | 9150E-Colour no. |
| Contact backrest with tilting seat | 530 mm | 9154E-Colour no. |
| Synchronous mechanism with weight regulation | 530 mm | 9157E-Colour no. |

* 20 mm increase in seat height with the synchronous mechanism.



ESD Basic 2 with castors

Seat height adjustment range*: 470 to 610 mm.

| Design | Height of backrest | Order no. |
|--|--------------------|------------------|
| Contact backrest | 430 mm | 9151E-Colour no. |
| Contact backrest with tilting seat | 530 mm | 9155E-Colour no. |
| Synchronous mechanism with weight regulation | 530 mm | 9158E-Colour no. |

* 20 mm increase in seat height with the synchronous mechanism.



ESD Basic 3 with glides and step

Seat height adjustment range*: 620 to 870 mm.

| Design | Height of backrest | Order no. |
|--|--------------------|------------------|
| Contact backrest | 430 mm | 9152E-Colour no. |
| Contact backrest with tilting seat | 530 mm | 9156E-Colour no. |
| Synchronous mechanism with weight regulation | 530 mm | 9159E-Colour no. |

* 20 mm increase in seat height with the synchronous mechanism.

ESD Unitec



The low-cost solution for solid performance



If you are looking for a budget-priced, basic model for use in ESD areas, ESD Unitec is a straightforward yet solid option. It offers all the standard functions and can be easily adjusted by the user. ESD Unitec is ideal for workplace situations that involve standing up as well as sitting down. Unitec has a

generously proportioned seat and a high backrest. Comprehensive discharge capability is not a requirement for many areas. Therefore, ESD Unitec does not feature the conductive plastic components and steel components with conductive coating found on our other ESD models. Nevertheless, there is absolutely no compromise in terms of how the upholstery manages to direct electrostatic charges down to the conductive base.



The characteristics of the bimos standard ESD protection system



-  **Conductive high-comfort upholstery** (choice of fabric or synthetic leather)
-  **Five volume conductive castors/glides**
-  Continuous **conductive connection** running from upholstery down to castors/glides



Standard functions for first-time buyers

- Seat height adjustment
- Backrest height adjustment
- Contact backrest

ESD Unitec

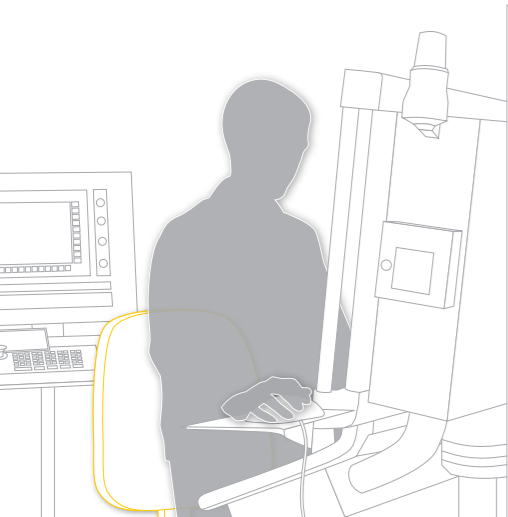

Design and materials

All the ESD Unitec upholstery options have appropriate antistatic properties. ESD Unitec features a sturdy five-legged base frame with flat lines made from sectional steel tubing. The colour of the frame is black.

Mechanisms and functions (for precise details, see pages 16-17)

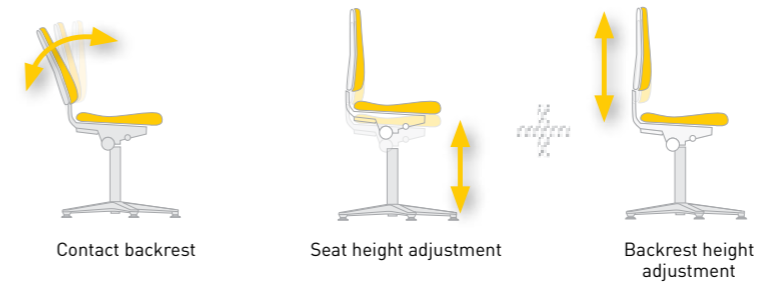

Accessories (for precise details, see page 141)



Ring-shaped armrest



Foot ring for Unitec

Finish and colour options for seat and backrest

| Finish | Black | Blue | Grey | Red |
|----------------------------|-------|------|------|------|
| Duotec ESD fabric | | | | |
| Order no. | 9801 | 9802 | 9811 | 9803 |
| Skai ESD synthetic leather | | | | |
| Order no. | 2571 | | | |



ESD Unitec 1 with glides

Seat height adjustment range: 440 to 590 mm.

| Design | Order no. |
|-----------------------------------|------------------|
| Duotec ESD fabric | 9650E-Colour no. |
| Skai ESD synthetic leather, black | 9650E-2571 |



ESD Unitec 2 with castors

Seat height adjustment range: 440 to 590 mm.

| Design | Order no. |
|-----------------------------------|------------------|
| Duotec ESD fabric | 9653E-Colour no. |
| Skai ESD synthetic leather, black | 9653E-2571 |



ESD Unitec 3 with glides and foot ring

Seat height adjustment range: 580 to 850 mm.

| Design | Order no. |
|-----------------------------------|------------------|
| Duotec ESD fabric | 9651E-Colour no. |
| Skai ESD synthetic leather, black | 9651E-2571 |

ESD Stools, ESD Footrests



ESD



Industrious assistants

Some of the tasks associated with ESD areas call for elevated seating positions or require workers to stand for long periods or to alternate between standing up and sitting down. As a result, their bodies are often subjected to a great deal of physical stress. bimos has the answer to these requirements: stools and footrests suitable for ESD areas that support the human body and relieve physical stress.

Stool functions

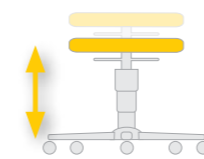

Seat height adjustment based on pneumatic spring system with easy ring control

Footrest functions

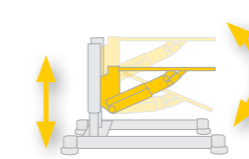

Pedal buttons enable convenient footrest adjustment while seated

Stool options



Polished aluminium
5 star base



Finish and colour options for seat (stools)

| Finish | Black | Blue | Grey | Red |
|----------------------------|-------|------|------|------|
| Duotec ESD fabric | | | | |
| Order no. | 9801 | 9802 | 9811 | 9803 |
| Skai ESD synthetic leather | | | | |
| Order no. | 2571 | | | |

ESD stool

With conductive fabric or synthetic leather upholstery. Conductive castors or glides.

| Design | Seat height | Order no. |
|---------------------------|--------------|------------------|
| with glides | 460 – 630 mm | 9467E-Colour no. |
| with castors | 460 – 630 mm | 9468E-Colour no. |
| with glides and foot ring | 570 – 850 mm | 9469E-Colour no. |

ESD Footrests

Height adjustment range: 100 to 340 mm.
Tilt adjustment range: 8° to 25°.
Conductive rubber tread.

| Design | Order no. |
|-------------------|-----------|
| Conductive glides | 9455E-217 |

Laboratory

**“Safety is a matter
of cleanliness –
even in chairs.”**



Laboratory

Sophisticated seating solutions for your laboratory

Laboratory work imposes unique seating requirements, which are unlike those of any other working environment. As well as the need for maximum hygiene and easy cleaning, laboratory chairs also have to meet a number of other requirements associated with routine laboratory tasks:

They have to allow for flexibility in terms of the work and must not take up too much space. Nevertheless, expectations remain high in respect of ergonomics and comfort, as laboratory tasks call for fine motor skills, and high levels of precision and concentration. The flexible configuration options take the strain out of demanding tasks that involve leaning forwards such as microscope or pipette work. The materials used are washable, can be disinfected and some even feature an antibacterial coating. During production, the utmost care is taken to ensure that there are no seams or gaps that could encourage germs or bacteria to grow. Yet at the same time, aesthetic appearance must not be compromised. The design and the colour variants fit perfectly into every laboratory. So bimos laboratory chairs – particularly our unique flagship Labster – are the solution of choice, whenever seating is needed in the laboratory.



The ideal attributes for any laboratory

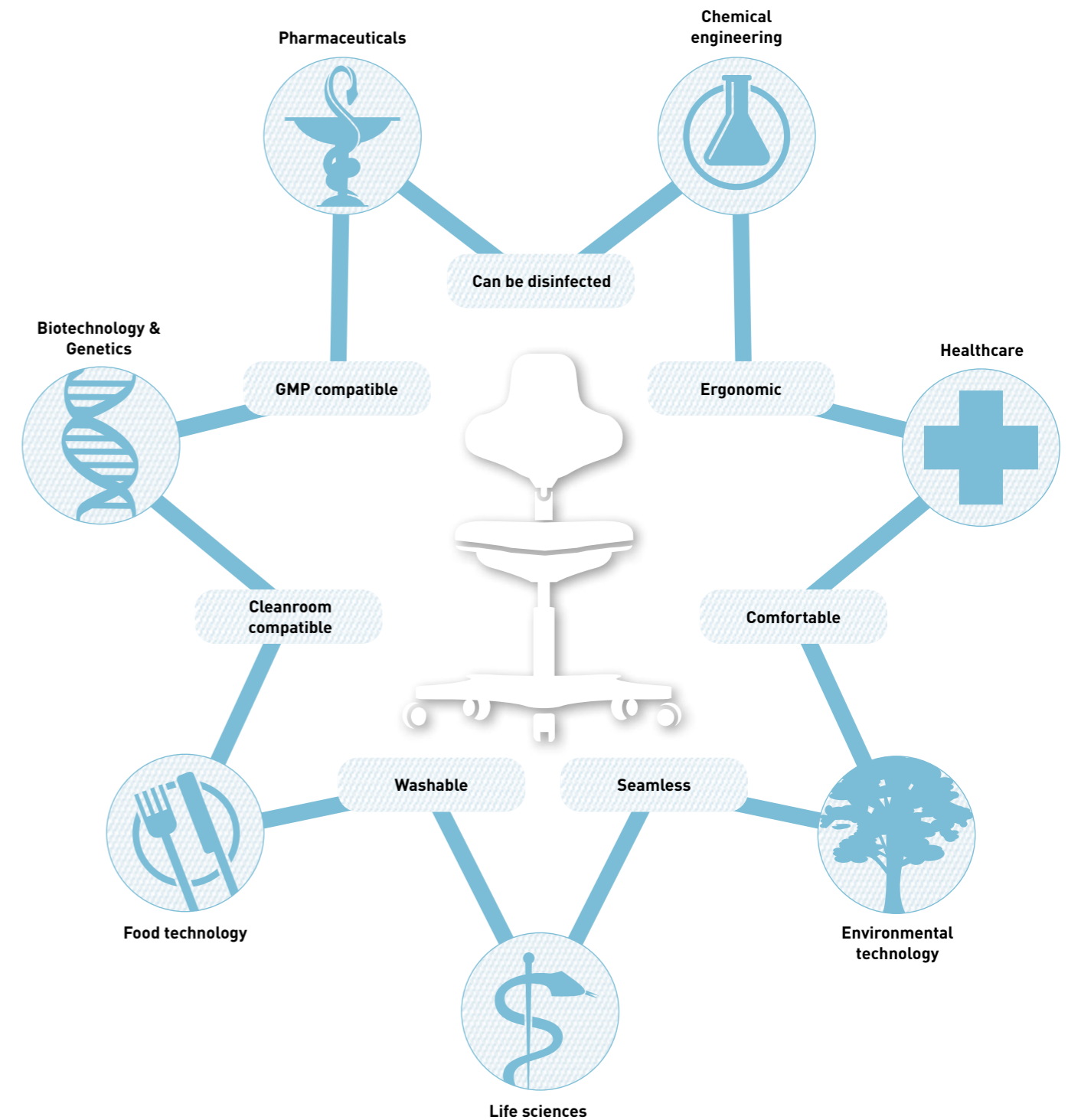

Labster



The world's first real laboratory chair

Labster is the world's first real laboratory chair. Unlike the usual laboratory adaptations of office or workshop chairs, Labster has been specially designed for the requirements of a laboratory. Labster has no sharp edges, thanks to its unique, seamless design concept, where even the mechanism is hidden under the soft, washable cover. There are no nooks and crannies where

microorganisms can lurk. All the surfaces can be cleaned quickly and thoroughly. In terms of ergonomics, Labster leaves nothing to be desired. For instance, the newly developed auto-motion technology ensures that the angle between the back and the thighs is always correct, no matter what type of work is being performed. This is not so surprising when you consider that Labster was designed on the basis of results of the Fraunhofer laboratory user study Lab 2020. So Labster sets new standards – it is even suitable for use in cleanroom conditions.

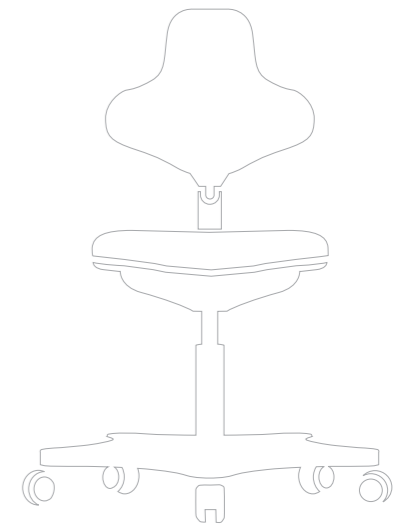

The factors that make Labster the world's first pure laboratory chair



Fraunhofer
TESTED
DEVICE
by bimos
Stuhl & Stuhlteile Labster
Report No. IS 0708-415



Ideal for labs in terms of ergonomics, function and comfort

- High level of comfort thanks to Skai synthetic leather and soft upholstery
- Superb ergonomics thanks to anatomically designed and task-oriented seat and back
- Height-adjustable backrest provides optimum support for the lumbar region
- Extremely user-friendly

Dynamic support thanks to auto-motion technology

- The special auto-motion technology is particularly suited to the leaning position that is typical of laboratory tasks.
- The seat and backrest respond dynamically to the movements of the upper body and thereby ensure the correct seat angle.

Hygiene and cleanliness

- All materials are resistant to disinfectants
- No gaps or seams
- Easy to disinfect
- Completely washable
- Mechanism is tucked away under a soft cover with integrated control panel

Adapts perfectly to everyday laboratory tasks

- Compact design
- Space-saving star base
- Attractive colour and shape concepts to complement the laboratory
- Complete product line for any workplace scenario

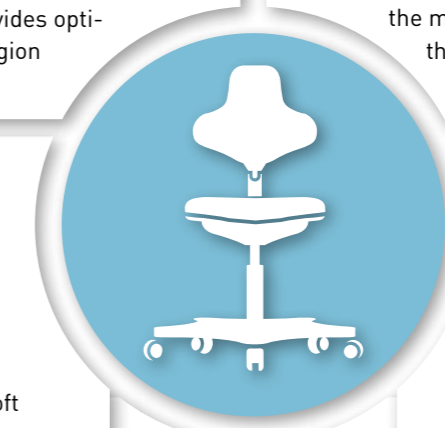

Meets the highest laboratory standards

- Design complies with GMP guidelines
- Meets the requirements of S1, S2 and S3 (safety class) biotechnology labs
- Air cleanliness class 3 in accordance with EN ISO 14644-1

Labster

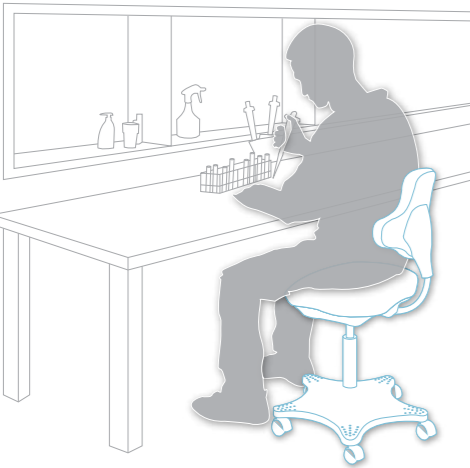

Design and materials

The ergonomically shaped comfort upholstery of Labster chairs is available either with the very soft Skai synthetic leather or with the very sturdy integral foam. Both surfaces are easy-care and resistant to disinfectants. Whereas you can choose between black and grey for the integral foam models, the synthetic leather is also available in blue, red, mint and white. The frame for all models is platinum grey.

Mechanisms and functions (for precise details, see pages 16-17)



Auto-motion technology



Seat height adjustment



Backrest height adjustment

Stool function

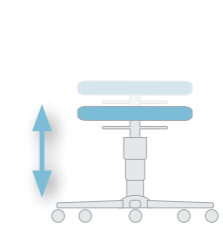

Seat height adjustment based on pneumatic spring system with easy ring control

Options

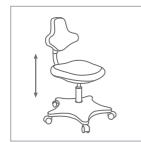

Seat height of 450 to 650 mm with Labster 2



ESD features

Accessories (for precise details, see page 141)



Foot ring for Labster 2



Foot ring for Labster 2 ESD

Upholstery finish and colour options

| Finish | Black | Blue | Grey | Red | Mint | White |
|------------------------|-------|------|------|------|------|-------|
| Skai synthetic leather | | | | | | |
| Order no. | 2571 | 6902 | 6911 | 6903 | 6914 | 6907 |
| Integral foam | | | | | | |
| Order no. | 2000 | | 2002 | | | |



Labster 2 with castors

Seat height adjustment range: 400 to 510 mm.
Option: 450 to 650 mm.

| Design | Order no. |
|----------------------------|-----------------|
| Skai synthetic leather | 9103-Colour no. |
| Integral foam | 9103-Colour no. |
| Skai synthetic leather ESD | 9103E-2571 |
| Integral foam ESD | 9103E-2000 |



Labster 3 with glides and foot ring

Seat height adjustment range: 550 to 800 mm.

| Design | Order no. |
|----------------------------|-----------------|
| Skai synthetic leather | 9101-Colour no. |
| Integral foam | 9101-Colour no. |
| Skai synthetic leather ESD | 9101E-2571 |
| Integral foam ESD | 9101E-2000 |



Labster stool with castors

Seat height adjustment range: 450 to 650 mm.

| Design | Order no. |
|----------------------------|-----------------|
| Skai synthetic leather | 9107-Colour no. |
| Integral foam | 9107-Colour no. |
| Skai synthetic leather ESD | 9107E-2571 |
| Integral foam ESD | 9107E-2000 |

Neon laboratory

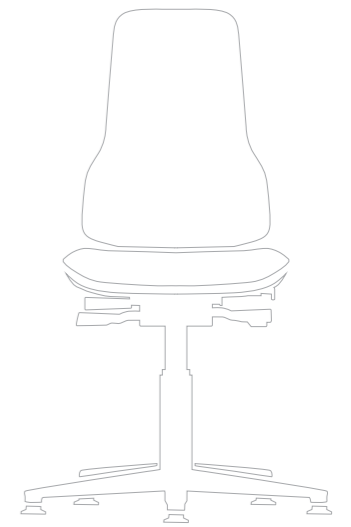

Comfort in your laboratory

Neon, the new generation workplace chair, cuts a fine figure in the laboratory too. Neon supports the forward-leaning sitting position that is often necessary in work in the laboratory. Neon is very elegant; its modern design matches the high-tech laboratory environment perfectly. Of course the laboratory version of Neon has all the characteristics you

would expect of a good laboratory chair. It is seamless, easy to clean, washable, and resistant to disinfectants. So Neon is always the ideal solution for the laboratory, when a really comfortable chair is needed. In addition to its outstanding ergonomic features, Neon is above all extremely comfortable. Its thick but deceptively slim-line upholstery ensures that sitting down even for a long test series is still comfortable. Its very sophisticated mechanisms support the body in its every movement. Yet Neon is quite simple. Operation is self-explanatory. The best ergonomic features are only really effective when the user understands them and wishes to put them to use.



Neon laboratory

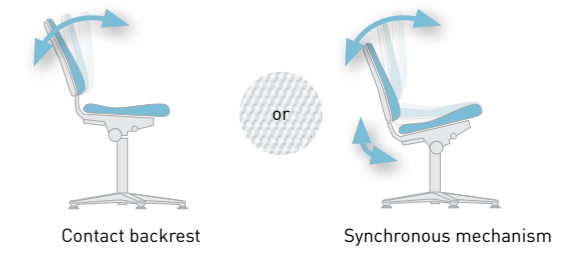

Mechanisms (for precise details, see pages 16-17)

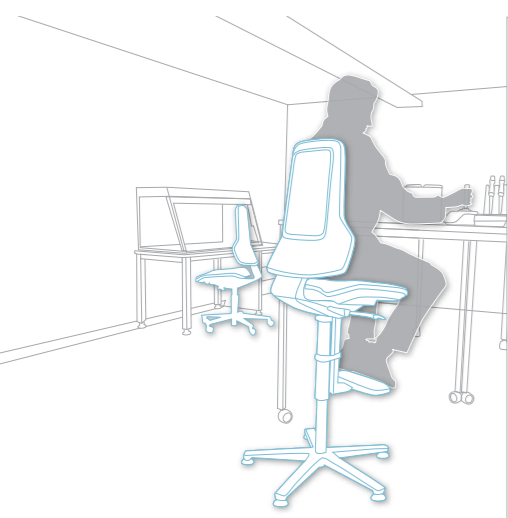

Design and materials

Neon is made of solid steel with an aluminium base. In the standard version, all the metal parts are black. On request, the base is also available in polished aluminium. In the laboratory version, the tough plastic parts are basalt grey. Neon is available with a choice of castors with load-sensitive brakes for hard floors or with abrasion-resistant glides. In addition, for the high version, there are optional Stop&Go castors available. The most striking feature of Neon is its flex strip. It is made of soft plastic and serves to protect the chair and its environment. There is a choice of three modern colours for the flex strip.

Ergonomics package

(for precise details, see pages 16-17)

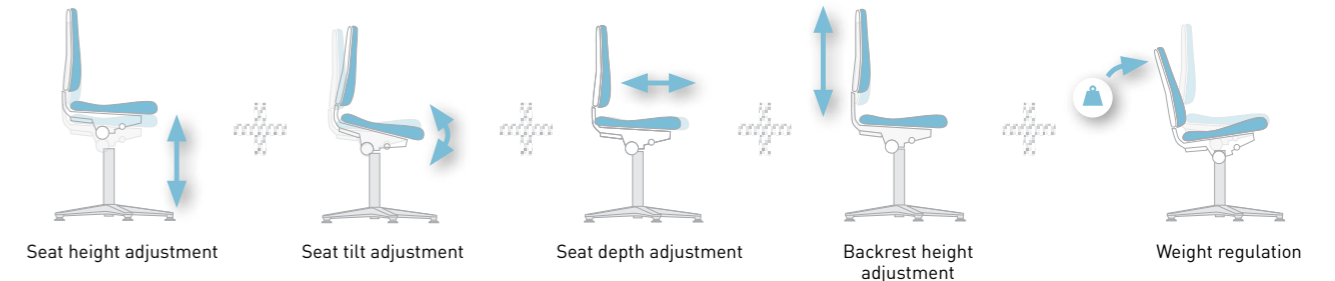

Options



Polished aluminium
5 star base

Accessories

(for precise details, see page 141)



Multifunction armrest

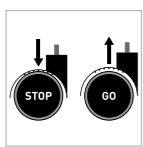

Stop&Go castors



Flex strip colour

| | Happy orange | Mars green | Cool grey |
|------------|--------------|------------|-----------|
| Flex strip | | | |
| Order no. | 3279 | 3280 | 3278 |

Neon 1 with glides

Seat height adjustment range: 450 to 620 mm.

| Design | Order no. |
|--|------------------------|
| Permanent contact inc. ergonomics package | 9560-Flex strip colour |
| Synchronous technology inc. ergonomics package | 9570-Flex strip colour |

Neon 2 with castors

Seat height adjustment range: 450 to 620 mm.

| Design | Order no. |
|--|------------------------|
| Permanent contact inc. ergonomics package | 9563-Flex strip colour |
| Synchronous technology inc. ergonomics package | 9573-Flex strip colour |

Neon 3 with mounting aid and glides

Seat height adjustment range: 590 to 870 mm.

| Design | Order no. |
|--|------------------------|
| Permanent contact inc. ergonomics package | 9561-Flex strip colour |
| Synchronous technology inc. ergonomics package | 9571-Flex strip colour |







Neon laboratory

Design and materials

Neon's innovative 1+1 system allows you to change the upholstery quickly and easily with a single click. With the 1+1 system, you order chair and upholstery elements separately (please note that you can only sit on the chair with an upholstery element). For use in laboratory areas, you can choose between two materials: an extremely

tough and pleasant-feeling structured integral foam, or soft and comfortable Magic synthetic leather. Both upholstery options are easy to look after, washable, and resistant to disinfectants. The 1+1 system makes Neon not just very comfortable, but also an extremely durable laboratory chair.

Upholstery finish and colour options

| Finish | Black | Blue | Grey |
|-------------------------|---|---|---|
| Magic synthetic leather |  |  |  |
| Order no. | MG01 | MG02 | MG11 |
| Integral foam |  |  |  |
| Order no. | 2000 | 2001 | 2002 |

Upholstery easy to change



Neon synthetic leather upholstery

washable, easy care, soft and comfortable, resistant to disinfectants

| Design | Order no. |
|-------------------------|-----------------|
| Magic synthetic leather | 9588-Colour no. |



Neon integral foam upholstery

extremely robust, durable, washable, resistant to mechanical damage, mild acids and alkalis

| Design | Order no. |
|---------------|-----------------|
| Integral foam | 9588-Colour no. |

Basic Laboratory



The tried-and-tested all-rounder for use in laboratories

Basic Laboratory is the low-cost laboratory model from bimos. However, even this basic version features all the essential attributes. Consequently, Basic Laboratory is a good entry-level model for laboratories with straightforward requirements.



Upholstery with Stamskin Top synthetic leather covering – A bacteria-free zone

- Antibacterial
- Antifungal
- Antimicrobial



Choice of three different mechanisms

- Contact backrest
- Contact backrest with seat tilt adjustment
- Synchronous mechanism with weight regulation



Available in two different frame colours

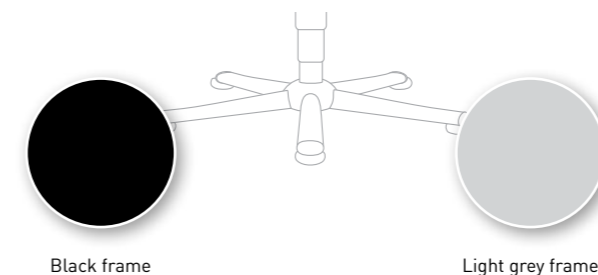

Basic Laboratory



Design and materials

Basic Laboratory can be supplied with Stamskin Top synthetic leather or with fabric upholstery. Not only is Stamskin Top easy to clean, but it also has anti-bacterial, antifungal and antimicrobial properties. Basic Laboratory features a sturdy steel 5 star base. The frame is available in either black or light grey.

Mechanisms and functions (for precise details, see pages 16-17)

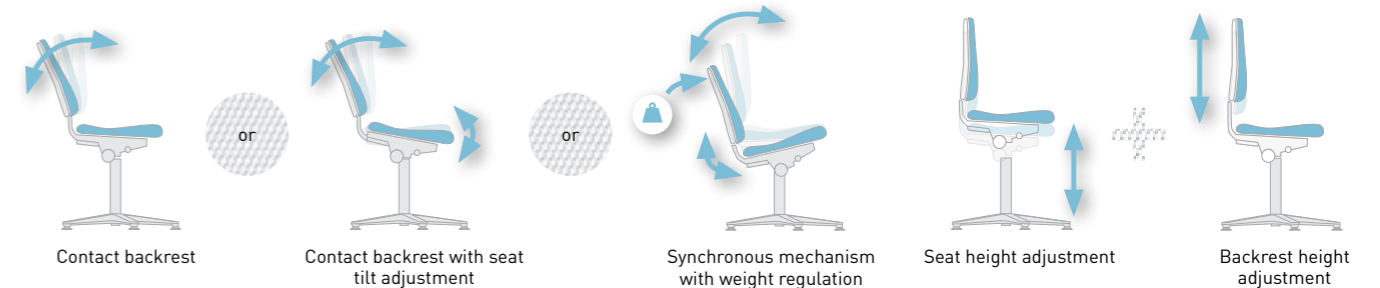

Options



Light grey frame

Polished aluminium 5 star base

Accessories (for precise details, see page 141)



Ring-shaped armrest, black

Ring-shaped armrest, light grey

Multifunction armrest

Foot ring

Upholstery finish and colour options

| Finish | Black | Blue | Grey | Red |
|--------------------------------|-------|------|------|------|
| Stamskin Top synthetic leather | | | | |
| Order no. | 4524 | 4523 | 4521 | 4508 |
| Duotec fabric | | | | |
| Order no. | 6801 | 6802 | 6811 | 6803 |



Basic Laboratory 1 with glides

Seat height adjustment range*: 470 to 610 mm.

| Design | Height of backrest | Order no. |
|--|--------------------|-----------------|
| Contact backrest | 430 mm | 9130-Colour no. |
| Contact backrest with tilting seat | 530 mm | 9132-Colour no. |
| Synchronous mechanism with weight regulation | 530 mm | 9135-Colour no. |

* 20 mm increase in seat height with the synchronous mechanism.



Basic Laboratory 2 with castors

Seat height adjustment range*: 470 to 610 mm.

| Design | Height of backrest | Order no. |
|--|--------------------|-----------------|
| Contact backrest | 430 mm | 9133-Colour no. |
| Contact backrest with tilting seat | 530 mm | 9134-Colour no. |
| Synchronous mechanism with weight regulation | 530 mm | 9138-Colour no. |

* 20 mm increase in seat height with the synchronous mechanism.



Basic Laboratory 3 with glides and step

Seat height adjustment range*: 620 to 870 mm.

| Design | Height of backrest | Order no. |
|--|--------------------|-----------------|
| Contact backrest | 430 mm | 9131-Colour no. |
| Contact backrest with tilting seat | 530 mm | 9137-Colour no. |
| Synchronous mechanism with weight regulation | 530 mm | 9136-Colour no. |

* 20 mm increase in seat height with the synchronous mechanism.

Sintec Laboratory

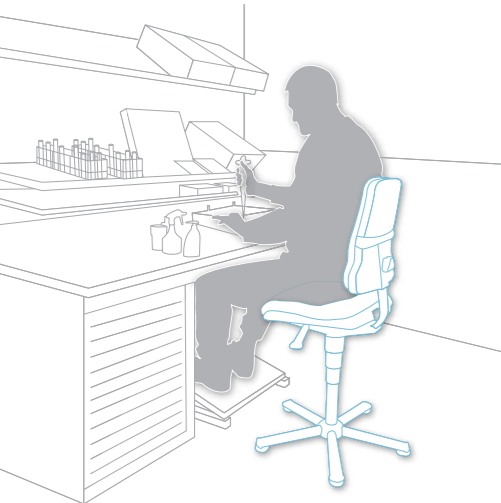

Design and materials

Sintec Laboratory is supplied with seat and backrest shells made from shock-proof and break-proof polypropylene as standard, which makes it particularly easy to clean. The seat and backrest upholstery is really quick and easy to replace. The chair features an epoxy-resin coated, five-legged base frame with flat lines made from sectional steel tubing. The colour of the frame is basalt grey. Sintec Laboratory can be supplied with Stamskin Top synthetic leather or with integral foam upholstery.

Mechanisms and functions (for precise details, see pages 16-17)

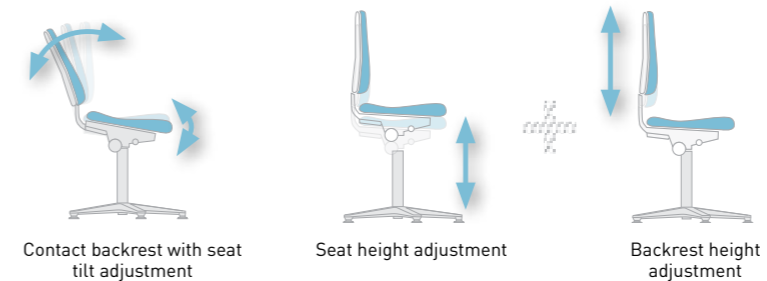

Options

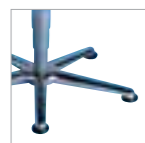

Polished aluminium 5 star base

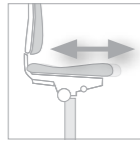

Seat depth adjustment

Accessories (for precise details, see page 141)



Ring-shaped armrest



Multifunction armrest



Foot ring

Upholstery finish and colour options

| Finish | Black | Blue | Grey | Red |
|--------------------------------|-------|------|------|------|
| Stamskin Top synthetic leather | | | | |
| Order no. | 4524 | 4523 | 4521 | 4508 |
| Integral foam | | | | |
| Order no. | 2001 | | | |



Stamskin Top synthetic leather upholstery

Washable, resistant to disinfectants, antibacterial, antimicrobial and antifungal.

| Design | Order no. |
|--------------------------------|-----------------|
| Stamskin Top synthetic leather | 9875-Colour no. |



Integral foam upholstery

Washable, resistant to mild acids/alkalis and disinfectants.

| Design | Order no. |
|---------------------|-----------|
| Integral foam, blue | 9865-2001 |



Sintec Laboratory 2 with castors

Seat height adjustment range: 430 to 580 mm.

| Design | Order no. |
|------------------------------------|-----------|
| Contact backrest with tilting seat | 9813-1000 |



Sintec Laboratory 3 with glides and step

Seat height adjustment range: 580 to 850 mm.

| Design | Order no. |
|------------------------------------|-----------|
| Contact backrest with tilting seat | 9811-1000 |

Isitec Laboratory

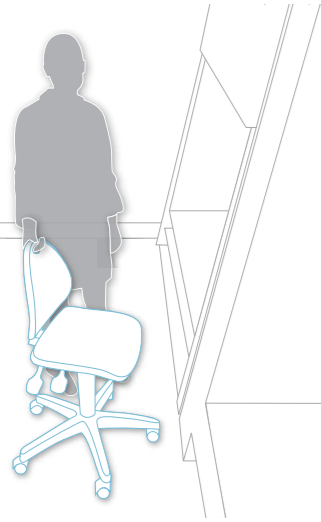

Design and materials

On the Isitec Laboratory, the seat and backrest are made from sealed SoftTouch integral foam. This material can be disinfected and is easy to clean. Despite Isitec Laboratory's minimalist approach, it is still very well equipped, making it an attractive budget solution for laboratory applications. Instead of the sturdy plastic 5 star base, it can also be supplied with a steel 5 star base as an option. The colour of the frame is black.

Mechanisms and functions (for precise details, see pages 16-17)

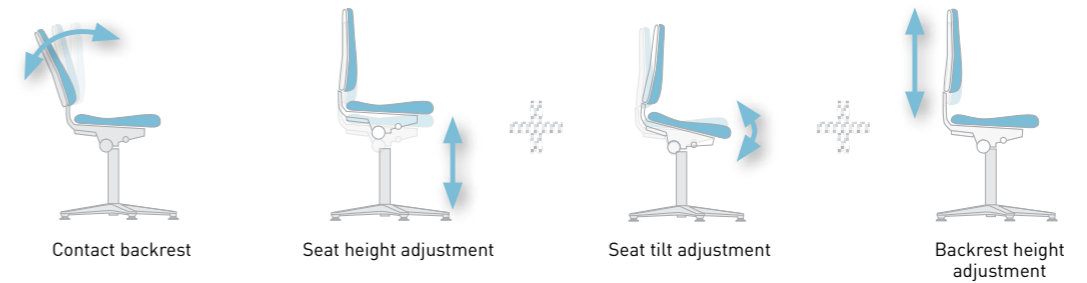

Options



Steel 5 star base

Accessories (for precise details, see page 141)



Ring-shaped armrest



Multifunction armrest



Foot ring

Upholstery finish and colour options

Finish **Black**

Integral foam



Order no.

2000



Isitec 2 with castors

Seat height adjustment range: 430 to 600 mm.

Design

Integral foam, black

Order no.

9608-2000



Isitec 3 with glides and foot ring

Seat height adjustment range: 580 to 850 mm.

Design

Integral foam, black

Order no.

9613-2000

Cleanroom

**“Zero-emission chair
affords pure
sitting pleasure.”**

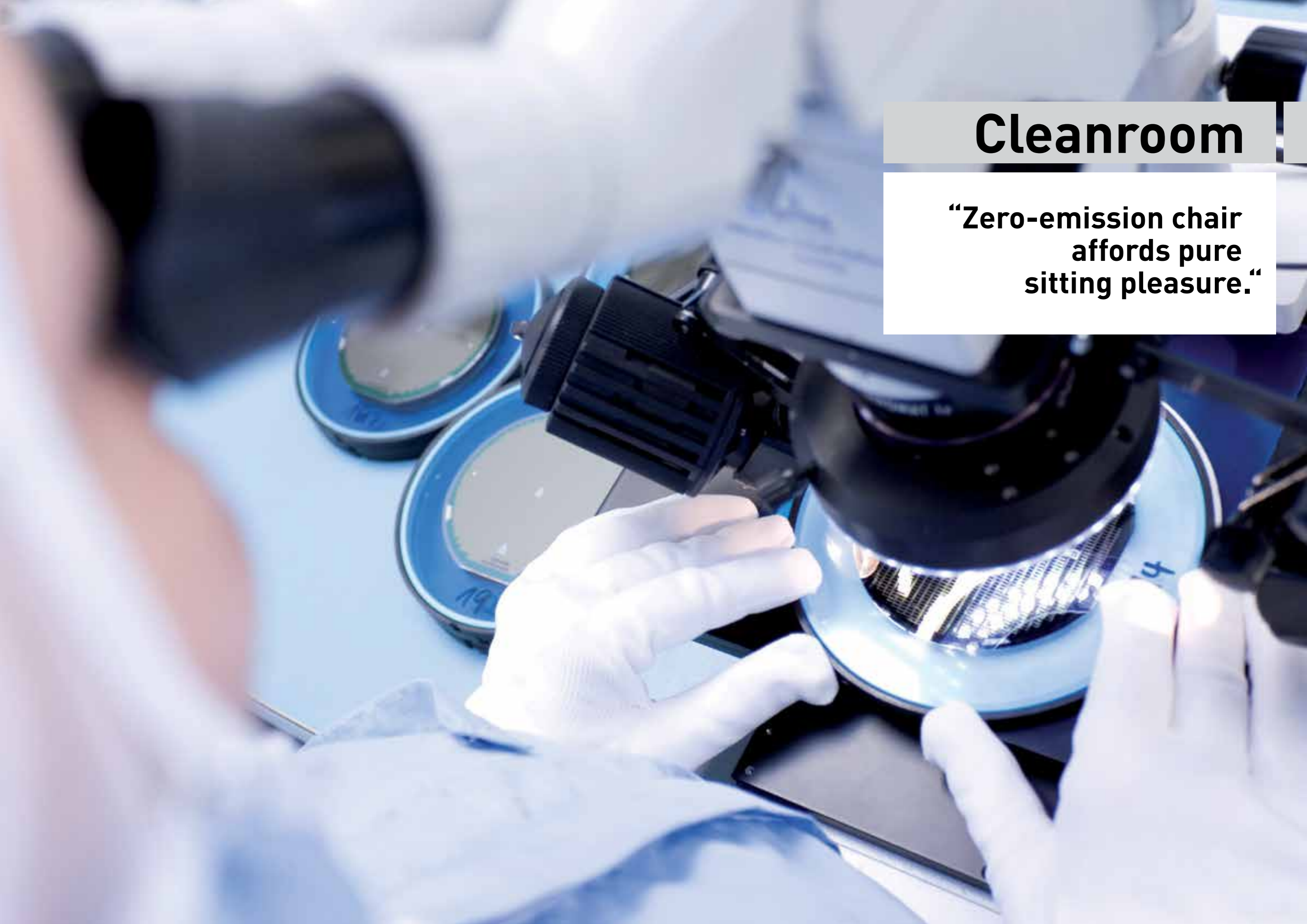

Cleanroom

Indispensable – Certified top-of-the-range seating for use in cleanrooms

In order to create “clean” or “sterile” rooms, measures have to be implemented to prevent products and processes from becoming contaminated. This is a key requirement of the microelectronics sector, the pharmaceuticals industry, microsystem production, optics, medical engineering and healthcare. That is why bimos has worked together with industry and research specialists to develop its innovative range of cleanroom chairs for use in extreme conditions.

We put our claims regarding the quality of these chairs to the test on a daily basis by subjecting them to a comprehensive series of tests that prove the low level of particle emissions and the reliability of the electrostatic discharge measures used. This quality is also borne out by empirical evidence arising from day-to-day use.

bimos cleanroom chairs boast astounding properties and meet the requirements of air cleanliness classification 3 in accordance with DIN EN ISO 14644-1, cleanroom classification 1 as defined by US Federal Standard 209E and the specifications of the EU GMP guidelines.

| bimos | Air cleanliness classification to: | | | Particle size and permissible number of particles per cubic metre of air acc. to EN ISO 14644-1 | | | | |
|-------|------------------------------------|-------------------|-----------------|---|----------|----------|-----------|----------|
| | EN ISO 14644-1 | EU GMP guidelines | US Fed St. 209E | ≥ 0,1 µm | ≥ 0,2 µm | ≥ 0,3 µm | ≥ 0,5 µm | ≥ 1,0 µm |
| 1 | – | – | – | 10 | 2 | – | – | – |
| 2 | – | – | – | 100 | 24 | 10 | 4 | – |
| 3 | – | – | 1 | 1000 | 237 | 102 | 35 | 8 |
| 4 | – | – | 10 | 10.000 | 2.370 | 1.020 | 352 | 83 |
| 5 | – | A/B | 100 | 100.000 | 23.700 | 10.200 | 3.520 | 832 |
| 6 | – | – | 1000 | 1.000.000 | 237.000 | 102.000 | 35.2000 | 8.320 |
| 7 | – | C | 10.000 | – | – | – | 352.0000 | 83.200 |
| 8 | – | D | 100.000 | – | – | – | 3.520.000 | 832.000 |

There are various definitions of cleanrooms, depending on the precise nature of the application and sector concerned. The table above provides an overview of various standards and how these relate to the bimos classifications.

It is the sophisticated design coupled with the perfect implementation of that design that make bimos cleanroom chairs top of their game.

bimos ensures the following in respect of all its cleanroom chairs:

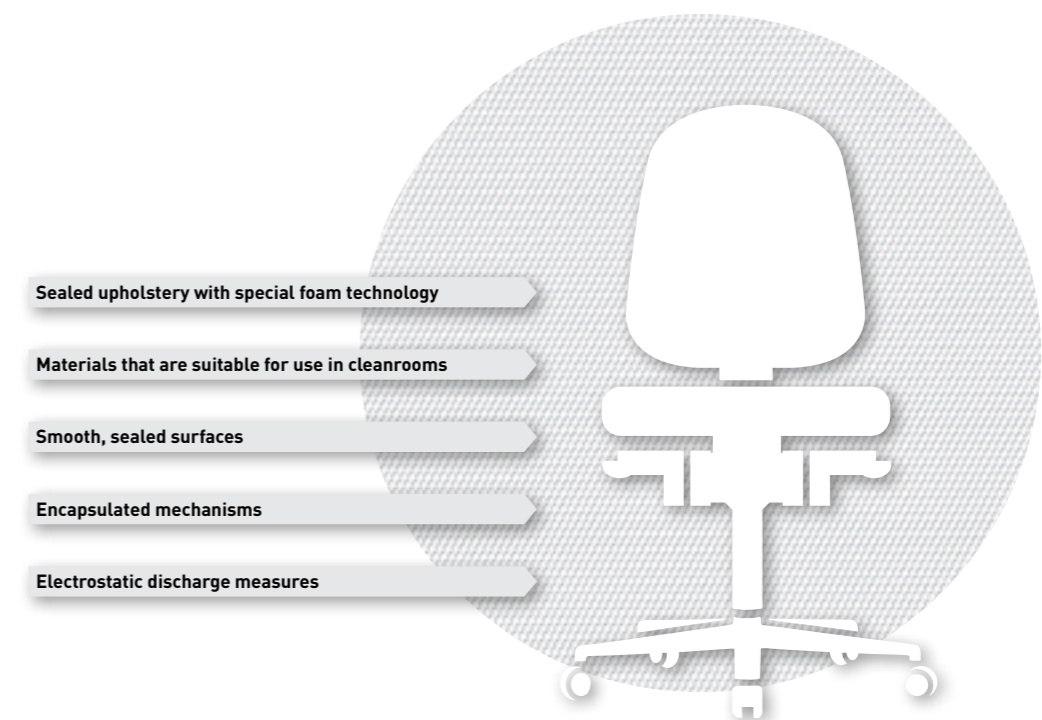

Cleanroom Plus

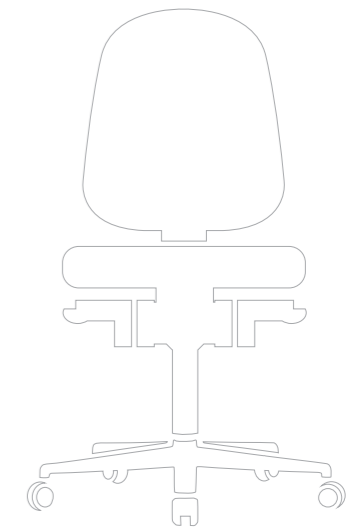

Cleanroom

The high-comfort solution for solid cleanroom performance

Our Cleanroom Plus chairs are the flagship of our cleanroom seating solutions. They offer excellent cleanroom properties and are equipped with a perfect electrostatic discharge system. Furthermore, these chairs cannot fail to impress with their superb ergonomic design and luxurious level of comfort. Consequently, Cleanroom Plus not only meets the technical requirements but also measures up to the expectations of those who work in cleanrooms every day.



Fraunhofer confirms the chairs' suitability for cleanrooms

The Fraunhofer IPA seal of approval certifies that Cleanroom Plus chairs are suitable for use in cleanrooms in compliance with the following standards:

- Air cleanliness classification 3 pursuant to DIN EN ISO 14644-1
- Air cleanliness classification 1 pursuant to US Fed. St. 209 E
- Provisions of the EU GMP guidelines
- Electrostatic discharge measures pursuant to EN 61340-5-1



Cleanroom properties



The smooth, sealed surfaces of the seat and backrest shells prevent swirl even when there is a constant flow of air through the filter system and stop the build-up of particles on the chair.

The synthetic leather, upholstery and upholstery support are permanently bonded using special foam technology to ensure that no particles can be emitted.

The sealed design of the seat and backrest cover means that all the moving parts of the chair's mechanical system are enclosed so that particles cannot escape.

All bimos cleanroom chairs feature electrostatic discharge measures in accordance with EN 61340-5-1 and offer reliable antistatic protection.

The chairs are supplied with a brilliantly polished and abrasion-resistant aluminium 5 star base. The seat support and backrest cover are both made from sheet steel, making them sturdy and durable.

Cleanroom Plus



Design and materials

On Cleanroom Plus, the seat and backrest shells are made from sheet steel and provide optimum protection against particle emissions. The metal components have a conductive coating and the plastic components are volume conductive. These components are all light grey. The synthetic leather cover, which is also conductive, has non-slip properties and ensures a firm grip even when the user is wearing smooth cleanroom clothing.

Mechanisms and functions (for precise details, see pages 16-17)

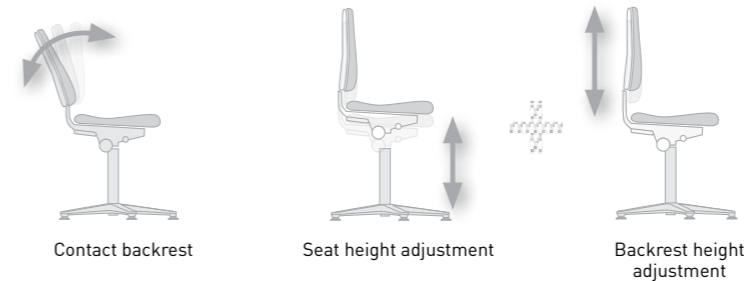

Options



Mushroom glides

Steel disc glides

Seat height adjustment range: 480 to 640 mm

Accessories (for precise details, see page 141)



Ring-shaped armrest

Foot ring

Upholstery finish and colour options

Finish **Black**

Skai ESD synthetic leather



Order no. 2571



Cleanroom Plus 2 Height of backrest: 380 mm

Seat height adjustment range: 440 to 565 mm.
Option: 480 - 640 mm.

| Design | Order no. |
|------------------|-----------|
| Contact backrest | 9181-2571 |



Cleanroom Plus 2 Height of backrest: 500 mm

Seat height adjustment range: 440 to 565 mm.
Option: 480 - 640 mm.

| Design | Order no. |
|------------------|-----------|
| Contact backrest | 9161-2571 |



Cleanroom Plus 3 Height of backrest: 380 mm

Seat height adjustment range: 630 to 890 mm.

| Design | Order no. |
|------------------|-----------|
| Contact backrest | 9183-2571 |

Cleanroom Basic

The tried-and-tested all-rounder for use in cleanrooms

An ergonomic design, superb cleanroom properties and reliable ESD measures are a lot to ask from a workplace chair. Yet Cleanroom Basic meets all these criteria and offers a high level of quality in the process. The fact that the chairs have to pass a comprehensive series of tests before they are awarded a test certificate and prove themselves in extreme working environments means that our claims of quality are not just empty words.

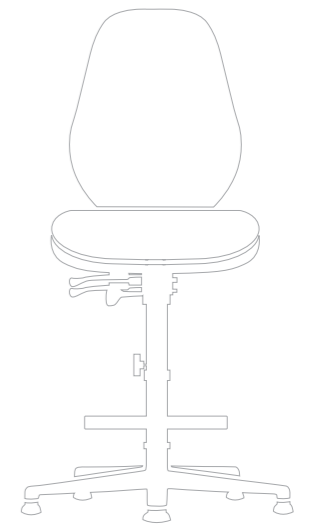

Fraunhofer confirms the chairs' suitability for cleanrooms

The Fraunhofer IPA seal of approval certifies that Cleanroom Basic chairs are suitable for use in cleanrooms in compliance with the following standards:

- Air cleanliness classification 3 pursuant to DIN EN ISO 14644-1
- Air cleanliness classification 1 pursuant to US Fed. St. 209 E
- Provisions of the EU GMP guidelines
- Electrostatic discharge measures pursuant to EN 61340-5-1



Cleanroom properties



The smooth, sealed surfaces of the seat and backrest shells prevent swirl even when there is a constant flow of air through the filter system and stop the build-up of particles on the chair.

The synthetic leather, upholstery and upholstery support are permanently bonded using special foam technology to ensure that no particles can be emitted.

All bimos cleanroom chairs feature electrostatic discharge measures in accordance with EN 61340-5-1 and offer reliable antistatic protection.

The chairs are supplied with a brilliantly polished and abrasion-resistant aluminium 5 star base. The seat support and backrest cover are made of plastic.

Cleanroom Basic

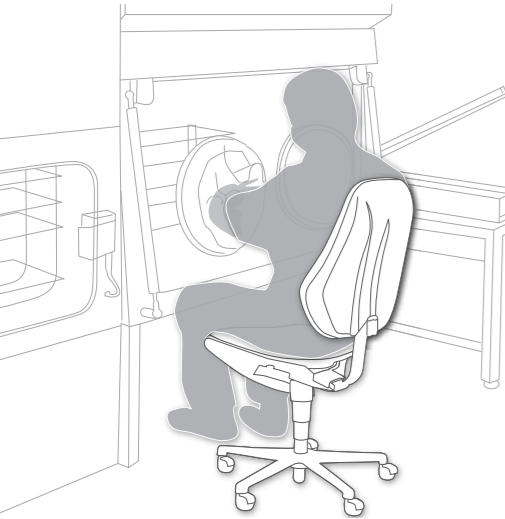

Design and materials

The base frame, which is made from die-cast aluminium, is brilliantly polished and is supplied with conductive castors/glides for hard floors. The non-tear synthetic leather cover, which is also conductive, has non-slip properties and ensures a firm grip even when the user is wearing smooth cleanroom clothing.

Mechanisms and functions (for precise details, see pages 16-17)

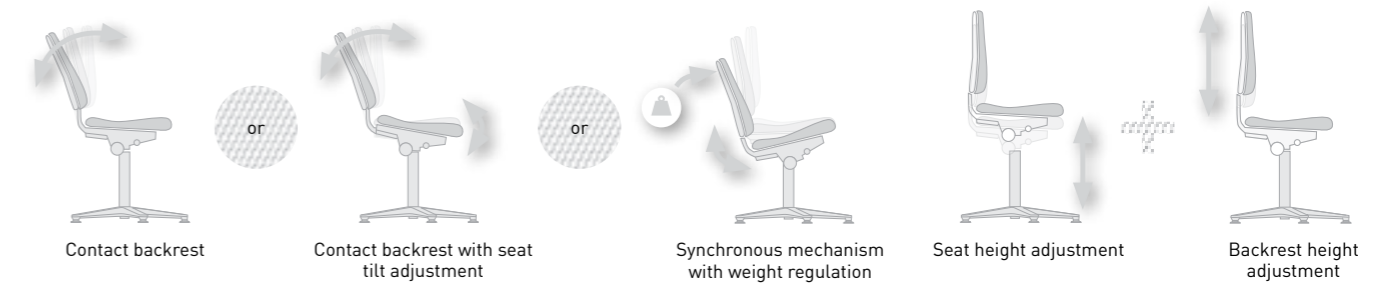

Options



Mushroom glides

Accessories (for precise details, see page 141)



Ring-shaped armrest



Multifunction armrest



Foot ring

Upholstery finish and colour options

Finish **Black**

Skai ESD synthetic leather



Order no. **2571**



Cleanroom Basic 2 with castors

Seat height adjustment range*: 470 to 610 mm.

| Design | Height of backrest | Order no. |
|--|--------------------|-----------|
| Contact backrest | 430 mm | 9140-2571 |
| Contact backrest with tilting seat | 530 mm | 9142-2571 |
| Synchronous mechanism with weight regulation | 530 mm | 9145-2571 |

* 20 mm increase in seat height with the synchronous mechanism.



Cleanroom Basic 3 with glides and step

Seat height adjustment range*: 620 to 870 mm.

| Design | Height of backrest | Order no. |
|--|--------------------|-----------|
| Contact backrest | 430 mm | 9141-2571 |
| Contact backrest with tilting seat | 530 mm | 9143-2571 |
| Synchronous mechanism with weight regulation | 530 mm | 9146-2571 |

* 20 mm increase in seat height with the synchronous mechanism.

Cleanroom Stools



Fraunhofer
TESTED®
DEVICE
Interstuhl Höcker 9468R
Report No. IN 0312-300



DIN
68877



warranty
5
years



Industrious assistants

Stools provide an ad hoc seating solution for anywhere within the cleanroom. They can also be used instead of chairs when there is a lack of space. The comprehensive range of stools completes the bimos cleanroom collection with these indispensable assistants. The base frames, which are made from die-cast aluminium, are brilliantly polished and are supplied with conductive castors/glides for hard floors. The synthetic leather cover also has conductive and non-slip properties.

Fraunhofer confirms the chairs' suitability for cleanrooms

The Fraunhofer IPA seal of approval certifies that Cleanroom Stools are suitable for use in cleanrooms in compliance with the following standards:

- Air cleanliness classification 4 pursuant to DIN EN ISO 14644-1
- Air cleanliness classification 10 pursuant to US Fed. St. 209 E
- Provisions of the EU GMP guidelines
- Electrostatic discharge measures pursuant to EN 61340-5-1

Functions (for precise details, see pages 16-17)

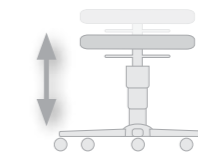

Seat height adjustment based on pneumatic spring system with easy ring control



Cleanroom Ergo Stool 1 with glides

Seat height adjustment range: 460 to 630 mm.

| Design | Order no. |
|-----------------------------------|------------|
| Skai ESD synthetic leather, black | 9467R-2571 |



Cleanroom Stool 2 with castors

Seat height adjustment range: 460 to 630 mm.

| Design | Order no. |
|-----------------------------------|------------|
| Skai ESD synthetic leather, black | 9468R-2571 |



Cleanroom Stool 3 with glides and foot ring

Seat height adjustment range: 570 to 850 mm.

| Design | Order no. |
|-----------------------------------|------------|
| Skai ESD synthetic leather, black | 9469R-2571 |

Finish and colour options for seat

Finish **Black**

Skai ESD synthetic leather



Order no. 2571



Standing work

**“Relief from stress
and strain when you
have to stand all day
– that’s a real gift.”**

Standing work

Relief from stress and strain for people who cannot sit down to work.

Almost every other member of the working population has to stand up to work for long periods of time. But standing up for prolonged periods subjects the human body to significant stress, and is responsible for a number of complaints relating to the heart and the circulatory and musculoskeletal systems.

There are some classic scenarios for standing work – when people have to change location often, or have to move around a lot, or have to communicate eye-to-eye with other people. A good standing rest needs to support a person doing these jobs, without getting in the way of the work itself. A standing rest must be space-saving, easy to transport from one place to another, and provide plenty of room for moving around and reaching things. At the same time, it must – the same as any seating solution – adapt to different body sizes, and support a person's posture, without forcing them into a particular position.

Our solutions for standing work give you the perfect support for any activity that cannot be undertaken while sitting down. Our standing rests range from simple supports for short-term stress-relief up to flexible standing rests that allow you to stand for prolonged periods without any signs of fatigue.

You find standing work everywhere:

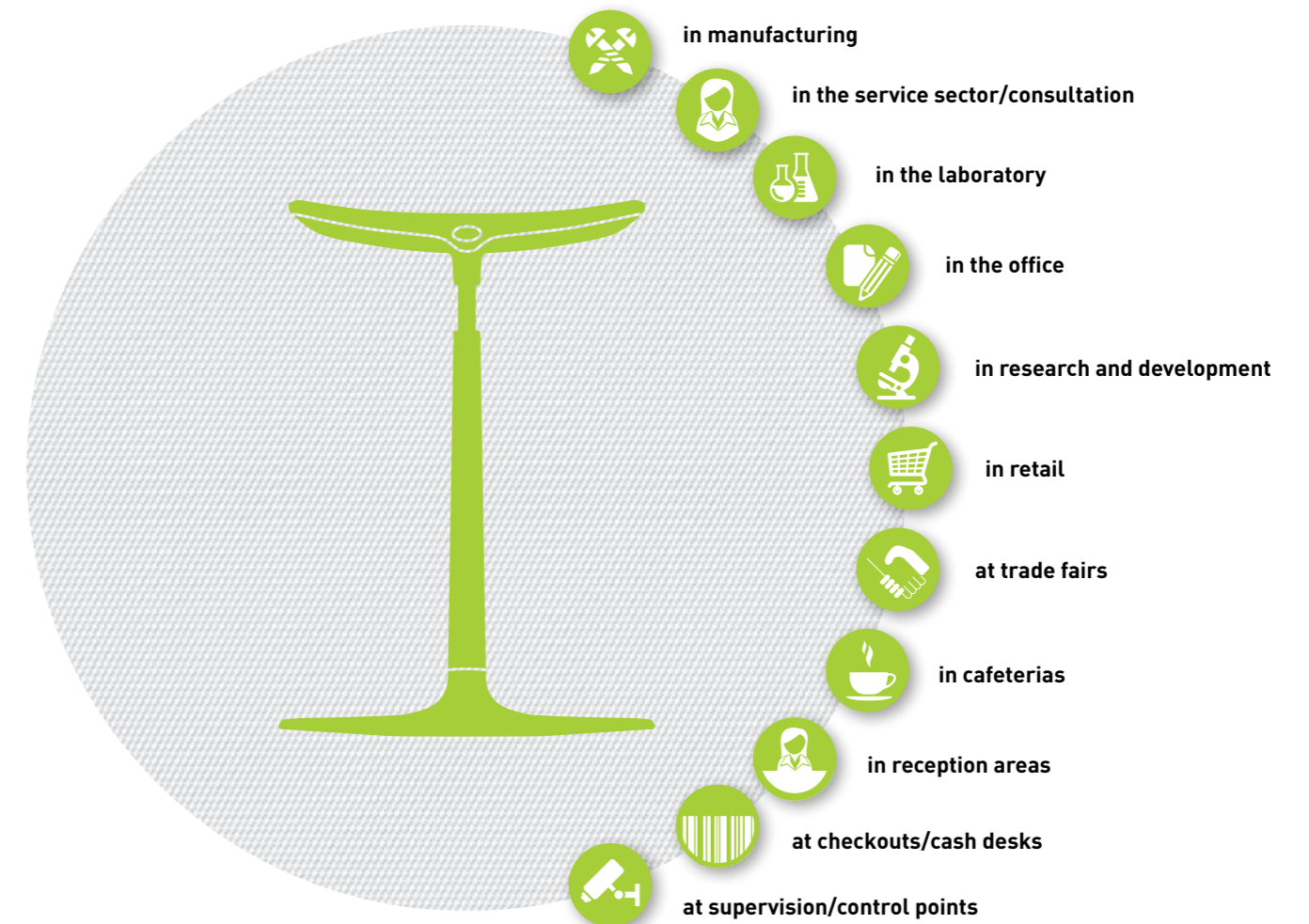

Fin / ESD Fin

The revolution in standing work

Fin is a fascinating new solution for practically every kind of standing work. It provides a completely new kind of sitting experience. Fin is incomparable, like no other standing rest on the market. It combines all the requirements demanded by work in industry, research, retail and office into an award-winning design. So Fin redefines standing work in a completely new way.

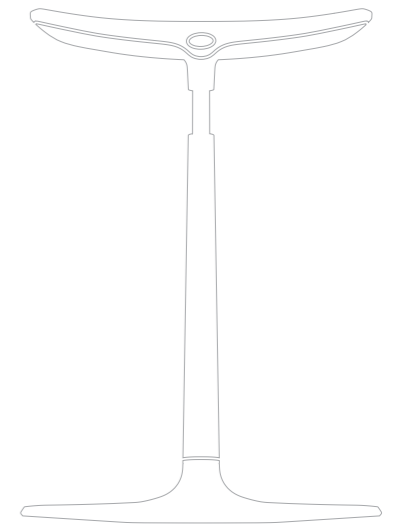

Fin ...

- ... relieves stress, and is wonderfully comfortable,
- ... is completely intuitive to use and operate,
- ... is robust and easy to clean,
- ... is secure, and feels safe,
- ... is space-saving, light and easy to move around.

Fin was designed by one of the best design studios in Germany – Phoenix Design – and has received a Red Dot Award from the Design Centre in Nordrhein-Westfalen. So Fin also sets new aesthetic standards.



- Practical: integral comfort handles**
- Comfortable: extra-wide comfort seat**
- Hardwearing: Soft Touch PU foam**
- Dynamic: seat can be swivelled by 20°**
- Simple: stepless height adjustment**
- Ergonomic: column tilts forward by 4° for optimum working posture and support**
- Resilient: comfortable gas spring**
- Safe: stable base**
- Flexible: changeable plastic and felt glides, depending on the kind of flooring**

Fin / ESD Fin



Design and materials

Fin is made of aluminium and has a seat made of Soft Touch PU foam. In the standard version, the frame has a blasted aluminium surface. The base can also be supplied in anthracite on request. In the standard version, there are four seat colours available. In addition, there is also a conductive ESD version in black. The ESD version of Fin has a discharge resistance of $10^6 \Omega$, so fulfilling the requirements of ESD standard EN 61340-5-1.

Functions (for precise details, see pages 16-17)

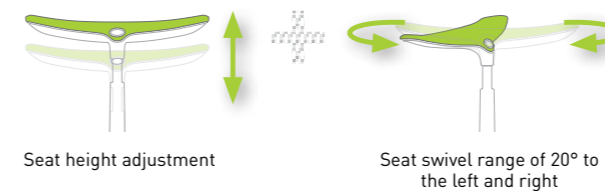

Options



Aluminium base coated, anthracite

Finish and colours for seat model 9144

| Finish | Black | Blue | Orange | Grey |
|---------------|-------|------|--------|------|
| Integral foam | | | | |
| Order no. | 2000 | 2001 | 2004 | 2002 |

Finish and colours for seat model 9144E

| Finish | Black |
|---------------|-------|
| Integral foam | |
| Order no. | 2000 |



Fin

Seat height adjustment range: 620 to 850 mm.

| Design | Order no. |
|---------------|-----------------|
| Integral foam | 9144-Colour no. |

ESD Fin

Seat height adjustment range: 620 to 850 mm.

| Design | Order no. |
|----------------------|------------|
| Integral foam, black | 9144E-2000 |

Labster standing rest



Fraunhofer
TESTED[®]
DEVICE
bimos
Stuhl&Stehhilfe/Labster
Report No. IS 0708-415



The standing rest for laboratory and more

Just like the Labster itself, the Labster standing rest was designed especially for use in the laboratory. A significant proportion of work in a lab is carried out standing and at various different stations. Work in a laboratory always requires high concentration and fine motor skills. The Labster standing rest is perfect for use in the laboratory: it is space-saving, designed without seams, has an enclosed mechanism, is easy to clean, and resistant to solvents and disinfectants. Its innovative rocker base makes for a dynamic standing-sitting experience, extending the radius of movement, and ensuring that the spine is always straight. So the Labster standing rest is perfect for taking away the strain of standing work in the laboratory, cleanroom, and workplaces with ESD requirements: and it conforms with air cleanliness class 3 in accordance with EN ISO 14644-1.

Functions (for precise details, see pages 16-17)



Seat height adjustment



Rocker base. Entire top section can be tilted by up to 7°

Options



Polished aluminium
5 star base

Finish and colour options for seat model 9106

| Finish | Black | Grey |
|---------------|---|---|
| Integral foam |  |  |
| Order no. | 2000 | 2002 |

Finish and colour options for seat model 9106E

| Finish | Black |
|---------------|---|
| Integral foam |  |
| Order no. | 2000 |



Labster Laboratory, Cleanroom

Seat height adjustment range: 650 to 850 mm.

| Design | Order no. |
|---------------|-----------------|
| Integral foam | 9106-Colour no. |



Labster Laboratory ESD, Cleanroom

Seat height adjustment range: 650 to 850 mm.

| Design | Order no. |
|----------------------|------------|
| Integral foam, black | 9106E-2000 |

Industrial-/ESD standing rest

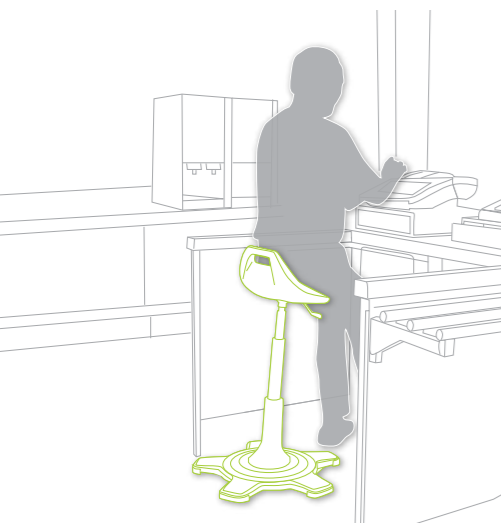

Support for your everyday work

Anyone who has to stand up for extended and monotonous periods of time needs support, since standing up motionless for a long time puts the body under a great deal of stress and strain. Our classic standing rests support the body and relieve the strain from the spinal column. The many different variations of base ensure that there is a version suitable for just about every use. Our industrial standing rests are extremely robust, and can stand up to even the toughest treatment. The industrial standing rest 2 is also available in an ESD version.

Functions (for precise details, see pages 16-17)

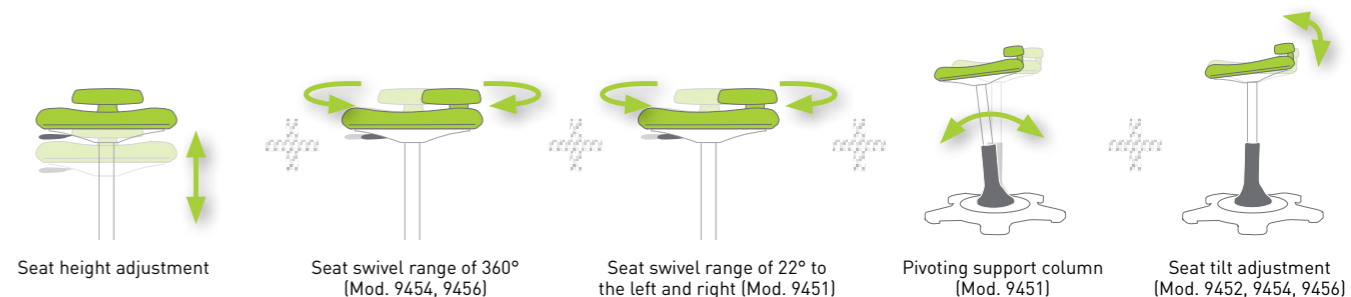

Industrial Standing Rest 1 Stable flat star base

Seat adjustment range: 650 to 850 mm.
Ratchet mechanism. Support column featuring self-aligning bearings and which can be pivoted forwards by 5°. Seat swivel range of 22° to the left and right. Seat made from integral foam and with carry handle.

| Design | Order no. |
|----------------------|-----------|
| Integral foam, black | 9451-2000 |



Industrial Standing Rest 2 Stable and ultra-flat disc base

Seat height adjustment range: 650 to 850 mm.
Pneumatic spring. Seat can be tilted forwards by 10°. Seat swivel range of 360°. Seat made from integral foam and with integrated carry handle.

| Design | Order no. |
|----------------------|------------|
| Integral foam, black | 9454-2000 |
| ESD standing rest | 9454E-2000 |



Industrial Standing Rest 3 Collapsible

Seat height adjustment range: 650 to 850 mm.
Ratchet mechanism. Seat can be tilted forwards by 10°. Seat made from integral foam and with integrated carry handle.

| Design | Order no. |
|----------------------|-----------|
| Integral foam, black | 9452-2000 |



Industrial Standing Rest 4 Fold-away leg

Seat height adjustment range: 640 to 840 mm.
Pneumatic spring. Seat can be tilted forwards by 10°. Seat swivel range of 360°. Seat made from integral foam and with integrated carry handle.

| Design | Order no. |
|----------------------|-----------|
| Integral foam, black | 9456-2000 |

Flex



The best support for sitting, standing and combined workplaces

Flex is a real all-rounder. It is the practical solution for workplaces where people have to sit as well as stand. To cope with this, Flex has a particularly wide range of heights that can be adjusted steplessly. Its ergonomic backrest and non-slip wave seat surface ensure that you feel completely safe and comfortable when you sit on the Flex. Comfort and resilience co-exist very happily in a Flex. Flex is at home in harsh working environments too. It is solidly built, and is extremely tough. Yet its upholstery is soft and boasts excellent ventilation, thanks to its wavy surface design. Flex is the practical solution when you need something light and uncomplicated.

Functions (for precise details, see pages 16-17)

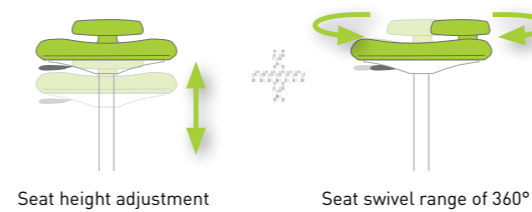

Finish and colour options for seat

| Finish | Black |
|---------------|---|
| Integral foam |  |
| Order no. | 2000 |



Flex 1 with castors

Seat height adjustment range: 450 to 650 mm.

| Design | Order no. |
|----------------------|-----------|
| Integral foam, black | 9408-2000 |



Flex 2 with glides

Seat height adjustment range: 510 to 780 mm.

| Design | Order no. |
|----------------------|-----------|
| Integral foam, black | 9409-2000 |



Flex 3 with glides and foot ring

Seat height adjustment range: 510 to 780 mm.

| Design | Order no. |
|----------------------|-----------|
| Integral foam, black | 9419-2000 |

Sweemo

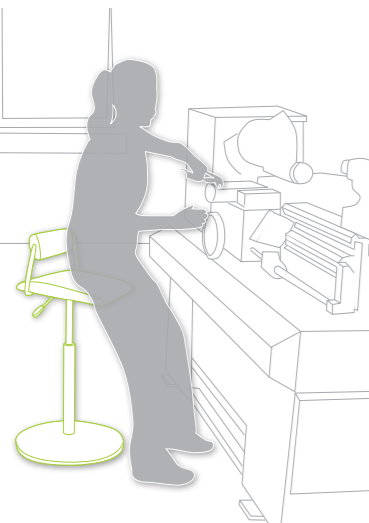

Dynamic sitting

Sweemo is neither a chair nor a stool, yet it combines the strengths of both. It is very versatile, uncomplicated and good-looking. The comfortable seat and backrest ensure comfort even in the smallest space. Sweemo is quite simply fun. Sweemo is suitable for absolutely any field of work. SweemoRoll has a round base with castors, allowing for a wide range of movement. You can rest your feet on the base. SweemoSwing and SweemoStand have a rocker base, and this helps to keep the pelvis mobile, protects you from an unhealthy rigid posture, and allows you great freedom of movement at work.

Functions (for precise details, see pages 16-17)

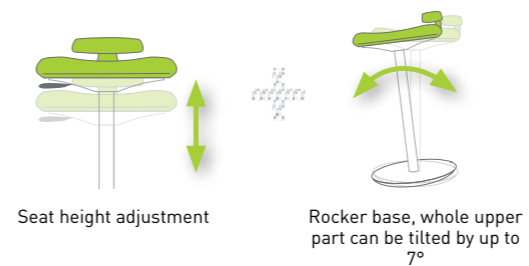

Surfaces and colours for seat and backrest

| Finish | Black | Blue | Red | Orange | White |
|------------------------|-------|------|------|--------|-------|
| Fabric | | | | | |
| Order no. | 5800 | 6062 | 5807 | 5816 | |
| Skai synthetic leather | | | | | |
| Order no. | 2571 | 6902 | 6903 | | 6907 |
| Integral foam | | | | | |
| Order no. | 2000 | | | | |



SweemoSwing with rocker base

Seat height adjustment range from 410 to 610mm.

| Design | Order no. |
|------------------------|-----------------|
| Fabric | 9280-Colour no. |
| Skai synthetic leather | 9280-Colour no. |
| Integral foam, black | 9280-2000 |



SweemoRoll with castors

Seat height adjustment range from 440 to 640mm.

| Design | Order no. |
|------------------------|-----------------|
| Fabric | 9283-Colour no. |
| Skai synthetic leather | 9283-Colour no. |
| Integral foam, black | 9283-2000 |



SweemoStand with rocker base

Seat height adjustment range from 580 to 850mm.

| Design | Order no. |
|------------------------|-----------------|
| Fabric | 9281-Colour no. |
| Skai synthetic leather | 9281-Colour no. |
| Integral foam, black | 9281-2000 |

Everything you need to know about chairs

In line with our philosophy that our chairs should fit seamlessly into your working environment, we have provided you with some helpful information on the pages that follow.

The options guide will help you select the most appropriate accessories and designs for your situation. As a result, you should be able to tailor the chair in precise accordance with your needs.

The guide to finishes provides an overview of all the available finish options. This will enable you to determine which material is best suited to a particular environment.

You can also refer to our dimensions table for all the relevant dimensions information. In this way, you can be sure that the chair dimensions are appropriate for the amount of available space.

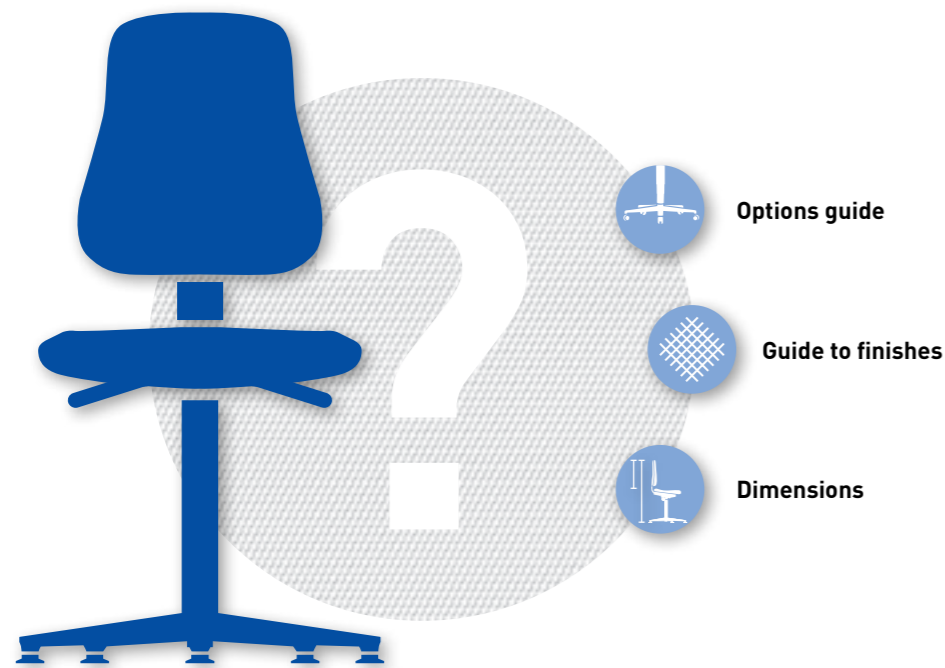

Options guide

Base frame

The base frame's shape and properties should be matched to the working environment in accordance with where it is going to be used. In the interests of ensuring maximum safety and convenience, bimos offers a variety of base frames so that you can choose exactly the right one for your workplace situation.



Steel 5 star base
This 5 star base, which is made from high-strength sectional steel tubing, is particularly robust and durable. Its flat design pre-vents people from tripping over it. Ideally suited to: production and manufacturing environments.



Aluminium 5 star base
5 star base made from polished aluminium. Highly suitable for use in laboratories or clean-rooms.



Disc base
This disc base has no corners or edges. This makes it impossible to trip over and very easy to clean. Therefore, it is particularly suited to working environments where large quantities of lint, dust or swarf are typical.

Armrests

If you have to remain seated for long periods, armrests will take the strain off your shoulders. Armrests can provide particularly effective support for detailed activities. However, they can also sometimes get in the way in situations where a high level of agility is required. That is why all our armrests are optional and do not pose any difficulties if you need to install them at a later date.



Ring-shaped armrests
The width of this ring-shaped armrest, which is made of plastic, can be adjusted by 20 mm.



Multifunction armrest
The height, width and depth of this armrest can all be adjusted to suit the individual user. The armrest pivots and can be locked into position.



Multifunction armrest ESD
The armrests made of conductive plastic can be adjusted in 4 dimensions.

Glides/castors



Glides
Our abrasion-resistant plastic glides have a large surface area and offer a superb level of stability. The flat design prevents you from tripping over them.



Castors
Dual-wheel safety castors with load-sensitive brakes have to be right for the floor. All bimos chairs are supplied with soft castors for hard floors as standard. Hard castors for soft floors are also available as an option.

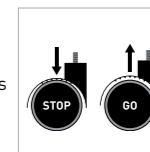

Stop&Go castors
So you want to stay put when you need to and the freedom to move unhindered when needs must? If so, then our Stop&Go castors offer the perfect solution. They can be retrofitted on all bimos models.

Foot ring

According to German DIN standard 68877, any chair with a seat height of over 650 mm has to have a step. Whenever our chairs exceed this height, we install the best possible step. It may even make sense to include a step in the case of standard working heights. To cater for this requirement, we offer a foot ring that can be retrofitted.



Chrome-plated foot ring
This chrome-plated foot ring can be retrofitted by attaching it to the chair column. It is height-adjustable.



Labster foot ring
This plastic foot ring, which features an extra-large footrest area, has been specially designed for our specialist laboratory model, Labster, and cannot be used with any other model. The ring is height-adjustable.

Workshops for the disabled

Workshops for the disabled are subject to special safety requirements. That is why we offer special accessories for use in this kind of environment.



Full belt safety harness
This full belt safety harness holds the upper body upright so that the user cannot fall off their chair. The harness can be retrofitted on our Sintec, Premitec and Solitec models.



Lap belt
This lap belt provides security for people who are particularly at risk, e.g. those who suffer from epileptic fits. The harness can be retrofitted on our Sintec, Premitec and Solitec models.



Swivel lock
For some activities, a swivelling chair can be a bit of a nuisance (e.g. when you need to apply force). This product enables you to lock the chair in position using a lever. The swivel lock can be retrofitted.

Guide to finishes

The easy way to find the right finish for your working environment:

Wood

This washable material is particularly well suited to environments that contain aggressive substances. Wood is highly resistant, robust, durable and easy to clean. Although wooden chairs cost less, the hard surface does make them slightly less comfortable to sit on.

Laminated beech

Our laminated beech consists of multi-bonded wood. Its ergonomic design fits snugly against your spine. The surface is coated with a clear varnish.



Fabric upholstery

Our fabric upholstery is particularly recommended for use in clean working environments. This high-quality fabric upholstery is breathable and can both absorb and expel moisture. The extremely soft surface guarantees maximum comfort. The upholstery can be cleaned using commercially available upholstery cleaning products.

Duotec

Our Duotec cover fabric, which is 95% polyacrylic and 5% Lycra, is particularly soft, hard-wearing and breathable. A conductive ESD version of the Duotec fabric is also available. This version has additional metal fibres woven into it.



Taff

Taff cover fabric is made of 100% polyester, and is especially soft and breathable. It is particularly resistant and durable. Taff is also available as a conductive ESD fabric. In this case, additional metal fibres are woven into it.



Genius

True to its name, this upholstery fabric really is a stroke of genius and is highly resistant. Thanks to its unique composition (50% polyamide, 33% new wool, 10% Visil and 7% rayon), Genius is 10 times more hard-wearing than conventional upholstery fabrics. This is backed up by its performance in the Martindale abrasion test (500,000 cycles).



Magic

Magic is a great-feeling modern synthetic leather with a fine structure. By looking at it, it is difficult to tell the difference between genuine leather and Magic. This synthetic leather is extremely soft and comfortable. But in spite of that it is extremely hard-wearing. Magic is especially low-maintenance. It is washable, and resistant to oil and disinfectants. A black conductive ESD version (with carbon pigments) is also available for use in ESD areas.



Superfabric

"Superfabric" is an innovative cover material like no other upholstery surface. Superfabric consists of a textile substrate covered with micro-studs. So Superfabric combines the advantages of fabric and integral foam. Superfabric is soft, comfortable and breathable. At the same time, it is very tough, cut resistant, non slip and easy to clean. Superfabric is a world first among cover materials, and bimos is the first manufacturer to use this material in workplace chairs.

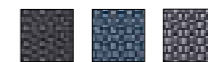

Integral foam

Integral foam is a good option for environments where the chair is likely to come into contact with aggressive substances such as oil, grease, swarf, mild acids and alkalis, moisture or flying sparks. The surface is highly resistant, extremely robust, washable and very easy to clean. Another plus point is the material's durability in that it can withstand pointed and sharp-edged objects. Thanks to its structured surface, integral foam has good climatic properties. A high level of comfort is guaranteed.

Integral foam – often known as PU or polyurethane foam – is extremely tough and easy to clean. Like our SoftTouch PU foam, integral foam is extraordinarily soft. A black conductive ESD version is also available for use in ESD areas.



Synthetic leather upholstery

Our synthetic leather upholstery is washable, resistant to disinfectants and easy to care for and clean. This soft and comfortable upholstery has a really nice feel to it. Nevertheless, there is still a risk of damage should it come into contact with extremely sharp-edged objects.

Stamskin Top

As well as having antibacterial, antimicrobial and antifungal properties, our high-quality synthetic leather is resistant to disinfectants, washable and easy to care for. Thanks to its special properties, Stamskin Top is ideal for use in a production or laboratory context.



Skai

This synthetic leather upholstery is ultra hard-wearing. It is washable and the fact that it is resistant to disinfectants makes it extremely easy to care for. In terms of its look and feel, Skai is virtually indistinguishable from real leather. A black conductive ESD version of the Skai synthetic leather upholstery (with carbon pigments) is also available for use in ESD areas. Skai is particularly suitable for use in production, ESD, laboratory and cleanroom environments.



■ Production
 ■ ESD area
 ■ Laboratory
 ■ Cleanroom
 ■ Standing work

| | Seat width | Seat depth | BR height | Seat height | Ø 5 star base | Weight |
|------------------------------|------------|------------|-----------|--------------|---------------|---------|
| Basic Laboratory | | | | | | |
| 9130 | 460 mm | 440 mm | 430 mm | 470 – 610 mm | 680 mm | 14,0 kg |
| 9131 | 460 mm | 440 mm | 430 mm | 620 – 870 mm | 680 mm | 17,5 kg |
| 9132 | 460 mm | 440 mm | 530 mm | 470 – 610 mm | 680 mm | 16,5 kg |
| 9133 | 460 mm | 440 mm | 430 mm | 470 – 610 mm | 680 mm | 14,5 kg |
| 9134 | 460 mm | 440 mm | 530 mm | 470 – 610 mm | 680 mm | 17,0 kg |
| 9135 | 460 mm | 440 mm | 530 mm | 490 – 630 mm | 680 mm | 16,5 kg |
| 9136 | 460 mm | 440 mm | 530 mm | 640 – 890 mm | 680 mm | 20,0 kg |
| 9137 | 460 mm | 440 mm | 530 mm | 620 – 870 mm | 680 mm | 20,0 kg |
| 9138 | 460 mm | 440 mm | 530 mm | 490 – 630 mm | 680 mm | 17,0 kg |
| Sintec Laboratory | | | | | | |
| 9811 | 480 mm | 430 mm | 420 mm | 580 – 850 mm | 680 mm | 17,0 kg |
| 9813 | 480 mm | 430 mm | 420 mm | 430 – 580 mm | 680 mm | 14,0 kg |
| Isitec Laboratory | | | | | | |
| 9608 | 440 mm | 410 mm | 340 mm | 430 – 600 mm | 640 mm | 12,0 kg |
| 9613 | 440 mm | 410 mm | 340 mm | 580 – 850 mm | 680 mm | 14,0 kg |
| Cleanroom Plus | | | | | | |
| 9161 | 480 mm | 470 mm | 500 mm | 440 – 565 mm | 650 mm | 14,5 kg |
| 9181 | 480 mm | 470 mm | 380 mm | 440 – 565 mm | 650 mm | 14,0 kg |
| 9183 | 480 mm | 470 mm | 380 mm | 630 – 890 mm | 650 mm | 17,0 kg |
| Cleanroom Basic | | | | | | |
| 9140 | 460 mm | 440 mm | 430 mm | 470 – 610 mm | 650 mm | 14,5 kg |
| 9141 | 460 mm | 440 mm | 430 mm | 620 – 870 mm | 650 mm | 17,5 kg |
| 9142 | 460 mm | 440 mm | 530 mm | 470 – 610 mm | 650 mm | 17,0 kg |
| 9143 | 460 mm | 440 mm | 530 mm | 620 – 870 mm | 650 mm | 20,0 kg |
| 9145 | 460 mm | 440 mm | 530 mm | 490 – 630 mm | 650 mm | 17,0 kg |
| 9146 | 460 mm | 440 mm | 530 mm | 640 – 890 mm | 650 mm | 20,0 kg |
| Cleanroom stools | | | | | | |
| 9467R | 400 mm | 400 mm | - | 460 – 630 mm | 650 mm | 6,5 kg |
| 9468R | 400 mm | 400 mm | - | 460 – 630 mm | 650 mm | 7,0 kg |
| 9469R | 400 mm | 400 mm | - | 570 – 850 mm | 650 mm | 8,5 kg |
| Fin | | | | | | |
| 9144 | 490 mm | 145 mm | - | 620 – 850 mm | 525 x 355 mm | 9,0 kg |
| ESD Fin | | | | | | |
| 9144E | 490 mm | 145 mm | - | 620 – 850 mm | 525 x 355 mm | 9,0 kg |
| Labster standing rest | | | | | | |
| 9106 | 360 mm | 380 mm | - | 650 – 850 mm | 490 mm | 7,0 kg |
| 9106E | 360 mm | 380 mm | - | 650 – 850 mm | 490 mm | 7,0 kg |
| Standing rest | | | | | | |
| 9451 | 370 mm | 240 mm | - | 650 – 850 mm | 600 mm | 10,5 kg |
| 9452 | 370 mm | 240 mm | - | 650 – 850 mm | 420 x 460 mm | 9,0 kg |
| 9454 | 370 mm | 240 mm | - | 650 – 850 mm | 470 mm | 10,0 kg |
| 9456 | 370 mm | 240 mm | - | 640 – 840 mm | 460 x 440 mm | 9,0 kg |
| ESD standing rest | | | | | | |
| 9454E | 370 mm | 240 mm | - | 650 – 850 mm | 470 mm | 10,0 kg |
| Flex | | | | | | |
| 9408 | 360 mm | 380 mm | - | 450 – 650 mm | 640 mm | 10,0 kg |
| 9409 | 360 mm | 380 mm | - | 510 – 780 mm | 640 mm | 11,0 kg |
| 9419 | 360 mm | 380 mm | - | 510 – 780 mm | 640 mm | 13,0 kg |
| Sweemo | | | | | | |
| 9280 | 360 mm | 360 mm | 100 mm | 410 – 610 mm | 490 mm | 6,0 kg |
| 9281 | 360 mm | 360 mm | 100 mm | 580 – 850 mm | 490 mm | 7,0 kg |
| 9283 | 360 mm | 360 mm | 100 mm | 440 – 640 mm | 490 mm | 6,0 kg |

Thank you for reading our catalogue. We hope that you have been able to find the right seating solution for your personal needs and workplace requirements. Perhaps you still have some questions. If so, please contact your local retailer or the bimos team, who will be happy to help.

We look forward to receiving your order.

Regards from

bimos

Your bimos partner



Mmax.nl

Achter de Kerken 49 1391LC ABCOUDE

T. 0031(0) 294285215

F. 0031(0) 294285204

E. info@Mmax.nl | W. www.Mmax.nl